

PP & PVDF Valves & Fittings

Chemtrol



For ideas that fit your industrial flow-control applications, you can count on Chemtrol. Our high quality line of thermoplastic valves and fittings are ideas that last. Ideas that save money. Ideas whose time has come.

Proven dependability.

Chemtrol flow-control products are unsurpassed in performance and longevity. With more than 55 years of experience in industrial thermoplastics, Chemtrol offers dependable products that work in the most demanding environments.



Innovative technology.

Great ideas flow from Chemtrol in PVC, CPVC, PP, and PVDF products for a wide range of flow-control applications.

Technical service and sales support.

Our technical specialists are some of the best in the business. As part of your team, they provide expert advice, solve problems, and assist you every step of the way.

Our distributors, sales professionals, and service representatives offer ideas, answer questions, and put their knowledge to work for you.

Education and training.

We help you learn about the benefits of thermoplastics through excellent programs: classes and seminars specific to your industry, presented at our manufacturing facility, or product and application-specific seminars conducted in the field. Our high-quality product and technical manuals are available on request, and a full listing of Chemtrol products is provided on our web site, www.chemtrol.com



Introduction	4
Introduction to Chemtrol	
Materials	5
Chemical Resistance	5
Product Line	6
Product Guide	8
Ball Valves	
Polypropylene Tru-Bloc [®] Ball Valves	9
Kynar [®] PVDF Tru-Bloc [®] Ball Valves	10
Check, Vent, and Foot Valves	
PP and PVDF True Union Ball Check Valves	11
Socket Fusion Equipment	12
Black & Chem-Pure [®] Natural Polypropylene Fittings	15
Kynar [®] Red and Natural PVDF Fittings	22
Reference Data	28
Standards	36
Product Specifications	37
Warranty	38

Copies of Chemtrol publications are available for download on www.chemtrol.com.

Introduction to Chemtrol

With more than 55 years of experience in industrial thermoplastics, Chemtrol offers dependable products that work in the most demanding environments.

The premium line of quality Chemtrol® valves are lightweight, corrosion-resistant, and maintenance-free – saving you time and money.

For specific recommendations of chemical compatibility, see the *Chem-Guide*. For engineering data related to plastic piping system design and installation and maintenance instructions, see the *Chemtrol Thermoplastic Piping Technical Manual*. All Chemtrol publications are available for download on www.chemtrol.com in PDF format.



True Union Ball Valves

The True Union feature, a Chemtrol introduction, so revolutionized the industrial plastic valve industry that it has become the standard followed by all major manufacturers. The purpose of the design is to permit the valve cartridge, i.e., the body containing all operational components, to be easily lifted from the piping system for servicing/replacement when the union nuts are backed off. Easy repair/replacement, interchangeability, distribution availability, technical service, and reliable quality are the synergistic rationale many plants and original equipment manufacturers have embraced while standardizing on Chemtrol® True Union Ball and Check Valves.

The laying length of the body and the heavy-duty modified-acme threads in the union connections to the body have not changed in the four distinct models' 40-year history of the valve. This permits fouled valve replacement with a new body cartridge, which will fit the old union nuts. No change in piping length is required.

The distinctive orange handle indicates "open/close" and direction of flow at a distance. And molded-in arrows on top of the handle dictate rotational direction to personnel for easy operation within 90° stops. For applications requiring handle removal, the D-ring stem flats indicate "open/close" and a molded-in arrow on top of the stem indicates flow direction.

The Model C seat-carrier design was modified to include an external thread which mated into the valve body threads, eliminating the separate retainer. This modification also eliminated the adjustment of the seat-carrier by the external nut and end connector, resulting in a sealing envelope that was independent of external forces. An energized O-ring was added under the PTFE seat that provided automatic adjustment to compensate for seat wear. This design modification continued the Tru-Bloc feature, preventing the seat carrier from being extruded out of the valve body when the external valve nut was removed.

Manufactured in PVC and CPVC through 2", the current Model D ball valve's seat-carrier internal threads and the external union nut threads were strengthened to provide an increased pressure rating of 250 psi at 73°F and improved the pressure ratings at higher temperatures. The end connector design was modified to provide wrench flats. The union nut OD was changed to provide improved gripping for strap wrenches. The Model D design continued the sealing envelope that was independent of external forces with an energized O-ring under the PTFE seat that provided automatic adjustment to compensate for seat wear. The Tru-Bloc feature was also retained.

The Evolution of Chemtrol® Ball Valves

As a result of continuous testing and improvements since the inception of the True Union Ball Valve, three distinct model changes have occurred. The original True Union Model A design had a seat-carrier that slid into the smooth bore of the valve body, held in place by the external nut and end connector. Tightening the external nut adjusted the compression of the PTFE seat onto the ball.

The first major evolution to the True Union Ball Valve, Model B, introduced the Tru-Bloc® concept, a functional safety feature. With this design a separate threaded retainer locked the seat-carrier into the body and prevented the seat-carrier from being extruded out of the valve body when the external nut was removed. This change is intended to prevent pressure on the other side of the valve from ejecting the internal components and fluid medium out of the open valve end and to further prevent possible injury to persons or property.

Materials

PVC

(Polyvinyl Chloride) PVC conforming to ASTM D1784, Classification 12454, formerly designated Type I, Grade 1, is the most frequently specified of all thermoplastic piping materials. It has been used successfully for more than 55 years in such diverse areas as chemical processing, industrial plating, chemical drainage, fresh and wastewater treatment, chilled and tower cooling water, deionized water manufacture and distribution, and irrigation sprinkler systems. PVC is characterized by high physical properties and resistance to chemical attack by strong acids and other oxidizers, alkalis, salt solutions, some organic chemical solutions, and many other chemicals. However, it is attacked by non-ionic surfactants, some vegetable oils (e.g., peanut), and many organic chemicals such as polar solvents (e.g., ketones), aromatics (i.e., benzene ring structure), and chlorinated hydrocarbons. The maximum service temperature of PVC is 140°F. With a design stress of 2,000 psi at 73°F, the long-term hydrostatic strength of PVC is as high as any of the major thermoplastic materials being used for solid piping systems. PVC is joined by solvent cementing, threading, or flanging.

Corzan® CPVC

(Chlorinated Polyvinyl Chloride) CPVC conforming to ASTM D1784, Classification 23447 is a resin created by the post-chlorination of a PVC polymer. The material's resistance to chemical attack is almost identical to that of PVC. And the physical properties of CPVC are very similar to those of PVC at 73°F, but the additional chlorine in the CPVC polymer extends its maximum service temperature to 200°F. For example, the design stress for CPVC is 2,000 psi at 73°F, identical to that of PVC. But its strength is only reduced to 500 psi at 180°F, as compared to 440 psi for PVC at 140°F. For more than 35 years, CPVC has proven to be an excellent material for hot corrosive liquids, hot and cold water distribution, and similar applications above the useful temperature range for PVC. CPVC may even be chosen over PVC in the 110°F to 140°F temperature range because its higher strength-at-temperature, requiring less frequent piping supports, can translate to a more favorable overall installed cost than PVC. CPVC is joined by solvent cementing, threading, or flanging.

PVDF (Kynar®)

(Polyvinylidene Fluoride) PVDF homopolymer conforming to ASTM D3222, Type I, Grade 2, is a tough, abrasion-resistant fluorocarbon material that has a design stress of 1,360 psi at 73°F and a maximum service temperature of 280°F. It has versatile chemical resistance to salts, strong acids, dilute bases, and many organic solvents, such as the aromatics (i.e., benzene ring structure), the aliphatics (i.e., paraffin, olefin, and acetylene hydrocarbons), and the chlorinated groups. And PVDF is ideally suited for handling wet or dry chlorine, bromine, and other halogens. However strong bases and some organic chemicals such as polar solvents (e.g., ketones) and esters attack it. No other solid thermoplastic piping material can approach the combined strength, working temperature, and chemical resistance characteristics of PVDF. It is joined by the thermo-sealing socket fusion process, threading, or flanging.

PVDF, absent of any color pigment, is transparent to ultraviolet light. So while PVDF is one of the few plastic materials that is not degraded by UV radiation, exposure of the fluid medium inside a piping system to direct sunlight can frequently adversely affect its stability. Therefore, all PVDF piping components that Chemtrol® produces for general chemical service, contain an FDA-approved red pigment to mask the penetration of UV rays.

Natural Kynar® PVDF Type I (polymerized in emulsion) homopolymer is notably free of metallic ions and foreign organic compounds. And since the resin does not require processing or other external additives to aid manufacturing or long-term stability, the hard-polish surface of components will remain intact, so that piping systems will not release particulate to the fluid medium. Further, there will be no surface micropores to encourage biological growth. Natural Kynar® systems are intended for ultra high pure water and chemical services, such as electronics, pharmaceuticals, and processed foods and beverages.

PP

(Polypropylene) PP as specified by ASTM D4101, is a member of the polyolefin family of pure hydrocarbon plastics. Although PP has half the strength of PVC and CPVC, with a design stress of 1,000 psi at 73°F, it may have the most versatile chemical resistance of the thermoplastic materials identified as the sentinels of industrial piping. Consider the fact that there are no known solvents for PP. As a result, it has been the material of choice for drainage of mixed industrial chemicals for over 40 years. As pressure piping, PP has no peers for concentrated acetic acid or hydroxides. It is also suitable for milder solutions of most acids, alkalis, salts, and many organic chemicals, including solvents. The nemesis for PP are strong oxidizers, such as the hypochlorites and higher concentrations of sulfuric, nitric, and hydrofluoric acids. They are Environmental Stress Cracking (ESC) agents for PP, meaning that time-to-failure is a function of the combined variables of concentration and temperature of the fluid and stress. Although PP is not recommended for some organic chemicals, such as polar and chlorinated solvents and the aromatics, the concern is permeation through rather than catastrophic damage of the molecular chain.

Black PP used in Chemtrol products is formulated with a minimum 2.5% carbon black. The plastic pipe industry recognizes PP formulated with this level of carbon black as suitable for long-term outdoor service.

Chem-Pure® Natural PP utilized to produce Chemtrol® piping products was selected because of its extremely low content of metals, organic compounds other than naturally pure propylene, and free ions. No pigments or other adulterants (natural) are added to the plastic resin. Chem-Pure® systems are intended for high purity chemicals or DI water. Chem-Pure systems are intended as an economic alternative to the ultra high purity PVDF systems typically found in the highly sophisticated electronic semi-conductor industry.

FKM

(Fluoroelastomer) FKM is compatible with a broad spectrum of chemicals. Because of this extensive chemical compatibility, spanning wide ranges of concentration and temperature, FKM has gained wide acceptance as a material of construction for valve o-rings and seats. These fluoroelastomers can be used in most applications involving mineral acids (with the exception of HCl), salt solutions, chlorinated hydrocarbons, and petroleum oils. FKM is not recommended for most strong alkali solutions.

EPDM

(Ethylene-propylene-diene monomer) EPDM is a terpolymer elastomer that has good abrasion and tear resistance and offers excellent chemical resistance to a variety of salt, acidic, and organic chemical solutions. It is the best material for most alkali solutions and hydrochloric acid, but is not recommended for applications involving petroleum oils or most strong acids.

PTFE

(Polytetrafluoroethylene) PTFE has outstanding resistance to chemical attack by most chemicals and solvents. PTFE has a temperature rating of -200°F to +500°F. It is a self-lubricating material used as a seat and/or bearing material in most Chemtrol® valves.

Chemical Resistance

While thermoplastic piping systems are useful in general water service because they are light-weight, easy to install, and cost-effective, they excel in corrosive environments, such as water and wastewater treatment, food and pharmaceuticals, chemical processing, mining, power plants, oil refineries and more. Choosing the proper material for corrosive fluids can be handled by consulting the NIBCO chemical resistance guide and understanding the effect that temperature will have upon plastic materials' strength.

Chemical resistance is the ability for a particular plastic material to maintain properties in contact with a chemical. To ensure comprehensive chemical compatibility, a piping system must take into consideration the chemical resistance of all system components, including, but not limited to, plastic components, solvent cements or thread pastes (if applicable), elastomeric seals, all valve components and lubricants. Testing under field conditions may be the best way to ensure selected materials will work in a particular application.

Kynar® is a registered trademark of Arkema Inc.
Corzan® is a registered trademark of The Lubrizol Corporation.

		Polyvinyl Chloride (PVC)		Chlorinated Polyvinyl Chloride Corzan® CPVC	
Typical Applications		Chemical processing, industrial plating, chilled water distribution, chemical drainage, and irrigation systems		Systems for hot corrosive liquids, hot and cold water distribution, chemical processing, industrial plating, deionized water lines, chemical drainage, waste water treatment systems, and similar applications above the temperature range of PVC	
Joining Methods		Solvent cementing, threading, or flanging		Solvent cementing, threading, or flanging	
Max. Service Temperature		140° F/60° C		200° F/93° C	
Fittings	Schedule 80	Socket– 1/2" through 12" Threaded– 1/4" through 4"		Socket– 1/4" through 12" Threaded– 1/4" through 4"	
	Large diameter	10" and 12" couplings, tees, 90° and 45° elbows, reducer bushings, and Van Stone flanges		10" and 12" couplings, tees, 90° and 45° elbows, reducer bushings	
Valves	Tru-Bloc®/True Union ball valves*	1/2" through 6" socket, threaded, and flanged connections		1/2" through 6" socket, threaded, and flanged connections	
	Tru-Bloc®/True Union ball check valves	1/2" through 4" with socket, threaded, or flanged ends		1/2" through 4" with socket, threaded, or flanged ends	
	Butterfly valves*	EPDM and FKM liner		EPDM and FKM liner 3" only	
	Multiport valves*	True Union 3-way/3-position; 1/2" through 2" with socket, threaded, or flanged ends		True Union 3-way/3-position; 1/2" through 2" with socket, threaded, or flanged ends	
	Specialty valves	Angle and Y pattern: 1/4" through 1" threaded Needle and Chemcock®: 1/4" threaded			

*For pneumatic or electric actuation.

Refer to Chemtrol Technical Manuals for pressure ratings at various temperatures.

Polypropylene
(PP)



Polyvinylidene
Fluoride
(KYNAR® PVDF)



<p>Black Polypropylene: Clean chemical processes, hot corrosive liquids, industrial plating, waste treatment systems</p>	<p>Natural Polypropylene: Deionized water systems, clean chemical processes, pharmaceutical operations, food processing</p>	<p>Red KYNAR® PVDF, which protects fluid medium from UV exposure, is an excellent material for general industrial applications, especially outdoor installations.</p>	<p>Natural KYNAR® (Unpigmented) PVDF is ideal for industries such as electronics, pharmaceuticals, and processed foods or beverages.</p>
<p>Thermo-seal fusion, threading, or flanging</p>	<p>Thermo-seal fusion, threading, or flanging</p>	<p>Socket heat fusion, threading, or flanging</p>	<p>Socket heat fusion, threading, or flanging</p>
<p>180° F/82° C</p>	<p>180° F/82° C</p>	<p>280° F/138° C</p>	<p>280° F/138° C</p>
<p>IPS socket type— 1/2" through 6" Threaded— 1/2" through 4"</p>	<p>Socket ends— 1/2" through 4" Threaded— 1/2" through 4"</p>	<p>IPS socket type— 1/2" through 6" Threaded— 1/2" through 2"</p>	<p>IPS socket type— 1/2" through 6" Threaded— 1/2" through 2"</p>
<p>1/2" through 4" with socket, threaded, or flanged ends</p>	<p>1/2" through 4" with socket ends</p>	<p>1/2" through 4" with socket, threaded, or flanged ends</p>	<p>1/2" through 4" with socket, threaded, or flanged ends</p>
<p>1/2" through 4" with socket, threaded, or flanged ends</p>		<p>1/2" through 4" with socket, threaded, or flanged ends</p>	<p>1/2" through 4" with socket, threaded, or flanged ends</p>
	<p>1/2" through 4" with metric spigot, IPS socket, or ANSI flanged ends.</p>		<p>1/2" through 4" with metric spigot, IPS socket, or ANSI flanged ends.</p>

Kynar® is a registered trademark of Arkema Inc.

Key to Chemtrol Valve Figure Number System

X XX XX - X - XX - SIZE

① ② ③ ④ ⑤ ⑥

① End Configurations

- S Socket
- F Flanged
- T Threaded (female)
- M Threaded (male)
- A Hose x Male Threaded
- W Wafer Style Butterfly
- U Universal (socket and threaded)

② Body Material

- 45 PVC Schedule 80
- 51 CPVC Schedule 80
- 61 Black Polypropylene (PP)
- 62 Chem-Pure® Natural Polypropylene (PP)
- 65 Red Kynar® PVDF
- 66 Natural Kynar® PVDF

③ Types of Valves

- AC Angle
- BC Ball Check
- BF Butterfly (Model B)
- BG Butterfly (Model C)
- CC Chemcock®
- CN Needle
- D2 Diverter (3-Way, 2-Position)
- FV Ball Foot
- M3 Multiport (3-Way, 3 Position)
- TB Tru-Bloc® True Union Ball Valve
- YP Y-Pattern

④ O-Ring Material

- E EPDM
- V FKM

⑤ Operating Mechanisms

- NO None
- LH Lever Handle, Manual
- RH Round Safety Handle, Manual
- GO Gear Operator, Manual

⑥ Size

State Valve Size

Black and Chem-Pure® (Natural) Polypropylene Tru-Bloc® True Union Ball Valve, Model C

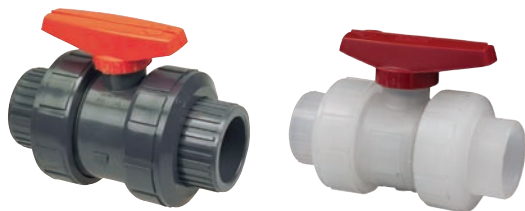

Construction Materials

Components ¹	Black PP	Nat. PP
1. Handle	Red PVC	
2. Stem	Nat. PP	Nat. PP
3. Body	Black PP	Nat. PP
4. Seat-Carrier	Nat. PP	Nat. PP
6. Union Nut	Black PP	Nat. PP
7. End Connector	Black PP	Nat. PP
8. Ball	Nat. GBPP ⁴	Nat. GBPP ⁴
9. Seat ² ; (2 ea.)	PTFE	
10. O-Ring ³ – Seat-Carrier; End Seal	FKM	
11. O-Ring ³ – Body; End Seal		
12. O-Ring ³ – Stem; OD Seal		
13. O-Ring ³ – Seat-Carrier; OD Seal		
14. O-Ring ³ – Seat-Carrier; Seat Energizer		
15. Plain-End Nipple; 2 ea. Spg x Spg	Black PP	N.A.
16. Flange – 2 ea. Socket-End	Black PP	N.A.
17. Stem; Friction Washer (4" Only)	PTFE	
18. Handle Bolt (4" Only)	Nat. PP	

- 1 All components except valve bodies are available as replacement parts.
- 2 Each replacement PTFE seat kit contains two seats.
- 3 Each replacement O-ring kit contains all the O-rings required to refurbish a particular size True Union Ball or Check Valve (regardless of model or style), or a minimum of two pipe unions.
- 4 Polypropylene filled with glass micro-beads.

Features

- Rated at 150 psi with non-shock water service at 73°F
- Designed with an energizer O-ring beneath the seat-carrier, Model C valves automatically adjust for seat wear.
- Full port design produces minimum flow restriction with the lowest possible pressure-drop.
- Valves are manufactured and assembled without exposure to silicone compounds.
- Distinctive red handle indicates “open/close” and direction of flow at a distance.

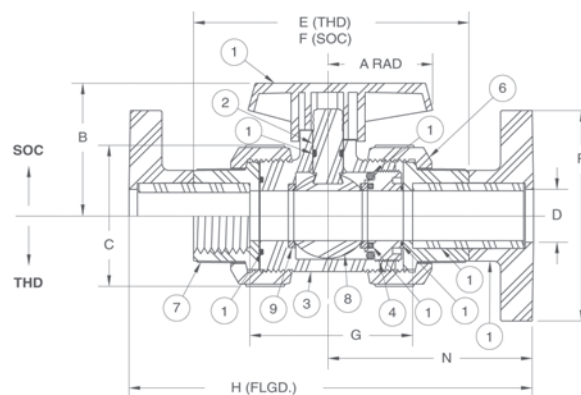

Chemtrol Figure Numbers

Valve Sizes	Materials	Elastomeric Trim	End Connections		
			Soc.	Thd.	Flgd.
1/2" – 4"	Black Polypro	FKM	S61TB-V ¹	T61TB-V ¹	F61TB-V ¹
1/2" – 4"	Natural Polypro	FKM	S62TB-V ²	T62TB-V ²	NA ²

- 1 Flanged figures are not available in the 1 1/4" size.
- 2 Socket Chem-Pure® (natural PP) Valves are available in the range of sizes shown except for the 1 1/4" size. Socket valves may be converted to threaded by exchanging the socket end connector with a threaded end connector. Flanged figures are not available.

Dimensions–Weights–Flow Coefficients

Valve Size	Profile						End-to-End					Fluid Flow Coefficient
	A ¹	B	C	D	N	P	E Thd.	F Soc.	G Soc.	H Flgd.	Approx. ² Wt. Lbs.	C _v ³
1/2	1.70	1.94	1.96	0.50	2.98	3.44	4.19	4.19	2.49	6.04	0.32	22
3/4	2.12	2.50	2.41	0.75	3.63	3.82	5.00	5.00	3.05	7.32	0.58	56
1	2.12	2.69	2.76	1.00	4.13	4.20	5.50	5.50	3.30	8.06	0.76	113
1 1/4	2.56	3.74	4.01	1.25	4.70	4.55	6.47	N/A	N/A	N/A	1.69	180
1 1/2	2.56	3.74	4.01	1.50	4.98	4.91	6.76	6.76	4.06	9.92	1.79	288
2	2.92	4.25	5.13	2.00	5.78	5.87	8.01	8.01	5.06	11.41	3.52	544
3	4.00	5.59	7.04	2.97	7.42	7.41	10.39	10.39	6.70	14.87	7.98	1348
4	8.00	6.05	8.59	4.01	8.52	8.85	12.22	12.22	7.78	17.52	15.78	2602

- 1 Handle is not symmetrical about centerline. Dimension shown represents the longest operational radius, but the handle position must be rotated 180° from that shown for the 4" size.
- 2 Weight shown represents the polypropylene threaded figure.
- 3 C_v values were computed for basic valve laying lengths (G).
- 4 No flanged figures are offered in any size for natural PP.

Red and Natural Kynar® PVDF Tru-Bloc® True Union Ball Valve, Model C



Features

- Rated at 150 psi with non-shock water service at 73°F
- Designed with an energizer O-ring beneath the seat-carrier, Model C valves automatically adjust for seat wear
- Full port design produces minimum flow restriction with the lowest possible pressure-drop
- Valves are manufactured and assembled without exposure to silicone compounds
- Distinctive black handle indicates “open/close” and direction of flow at a distance

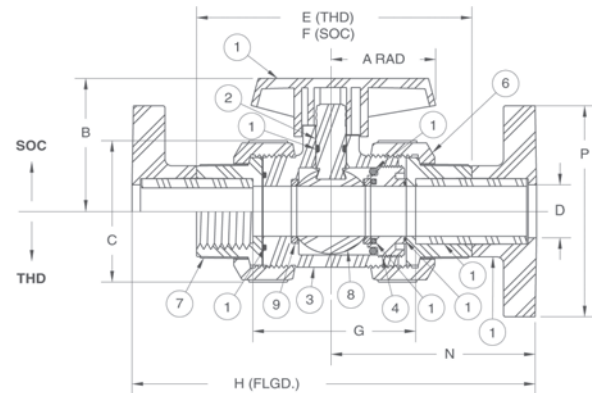

Chemtrol Figure Numbers

Valve Sizes	Material	Elastomeric Trim	End Connections		
			Soc.	Thd.	Flgd.
1/2"– 4"	Red PVDF ¹	FKM	S65TB-V	T65TB-V	F65TB-V
1/2"– 4"	Natural PVDF ¹	FKM	S66TB-V	T66TB-V	F66TB-V

¹ No Kynar® pipe, fittings, or valves are offered in the 1 1/4" size.

Construction Materials

Components ¹	Red PVDF	Nat. PVDF
1. Handle	Black PP	
2. Stem	Nat. PVDF	Nat. PVDF
3. Body	Red PVDF	Nat. PVDF
4. Seat-Carrier	Nat. PVDF	Nat. PVDF
6. Union Nut	Red PVDF	Nat. PVDF
7. End Connector	Red PVDF	Nat. PVDF
8. Ball	Nat. PVDF	Nat. PVDF
9. Seat ² ; (2 ea.)	PTFE	
10. O-Ring ³ – Seat-Carrier; End Seal	FKM	
11. O-Ring ³ – Body; End Seal		
12. O-Ring ³ – Stem; OD Seal		
13. O-Ring ³ – Seat-Carrier; OD Seal		
14. O-Ring ³ – Seat-Carrier; Seat Energizer		
15. Plain-End Nipple; 2 ea. Spg x Spg	Red PVDF	Nat. PVDF
16. Flange – 2 ea. Socket-End	Red PVDF	Nat. PVDF
17. Stem; Friction Washer (4" Only)	PTFE	
18. Handle Bolt (4" Only)	Nat. PP	

- ¹ All components except valve bodies are available as replacement parts.
² Each replacement PTFE seat kit contains two seats.
³ Each replacement O-ring kit contains all the O-rings required to refurbish a particular size True Union Ball or Check Valve (regardless of model or style), or a minimum of two pipe unions.

Dimensions—Weights—Flow Coefficients

Valve Size ⁴	Profile						End-to-End					Fluid Flow Coefficient
	A ¹	B	C	D	N	P	E Thd.	F Soc.	G Soc.	H Flgd.	Approx. ² Wt. Lbs.	C _v ³
1/2	1.70	1.94	1.95	0.50	2.98	3.41	4.19	4.19	2.49	6.04	0.47	22
3/4	2.12	2.50	2.36	0.75	3.63	3.77	5.00	5.00	3.05	7.32	0.84	55
1	2.12	2.69	2.75	1.00	4.13	4.15	5.50	5.50	3.30	8.06	1.15	112
1 1/2	2.56	3.74	3.98	1.50	4.98	4.86	6.76	6.76	4.06	9.92	2.59	285
2	2.92	4.25	5.13	2.00	5.78	5.82	8.01	8.01	5.06	11.41	5.30	540
3	4.00	5.59	6.99	2.90	7.42	7.31	10.39	10.39	6.70	14.87	12.58	1348
4	8.00	6.05	8.54	3.95	8.52	8.70	12.22	12.22	7.78	17.52	24.41	2602

- ¹ Handle is not symmetrical about the centerline. Dimension shown represents the longest operational radius, but the handle position must be rotated 180° from that shown for the 4" size.
² Weight shown represents the socket figure.
³ C_v values were computed for the basic valve laying lengths (G).
⁴ No pipe, fittings, or valves are offered in the 1 1/4" size.

Polypropylene and Kynar® PVDF True Union Ball Check, and Vent Valves

Chemtrol Figure Numbers

Type Valve	End Conn	Elastomeric Trim	Materials			
			Black Polypro	Chem-Pure Natural Polypro	Red PVDF	Natural PVDF
Ball Check Valve	Soc.	FKM	S61BC-V	S62BC-V	S65BC-V	S66BC-V
	Thd.	FKM	T61BC-V	NA	T65BC-V	T66BC-V
	Flgd.	FKM	F61BC-V	NA	F65BC-V	F66BC-V

Features

- Rated at 150 psi with non-shock service at 73°F
- Gravity ball check may be converted for air or gas venting by replacement of standard ball with natural polypropylene floater ball. Then install valve upside down for fluid to lift ball into seat.
- Free oscillation of ball in guide ribs facilitates full port flow with minimum turbulence and chatter.
- Equally effective in checking back flows from head pressure on the discharge or suction sides of pump.

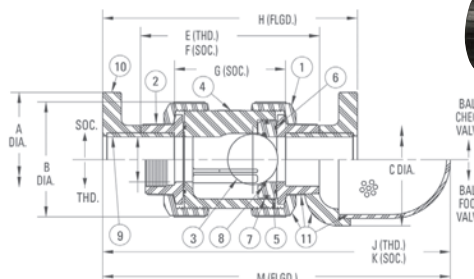

Construction Materials

Components ¹	Black PP	Nat. PP	Red PVDF	Nat. PVDF
1. Union Nut	Black PP	Nat. PP	Red PVDF	Nat. PVDF
2. End Connector	Black PP	Nat. PP	Red PVDF	Nat. PVDF
3. Ball – Standard for Check or Foot Valve	Nat. GBPP ⁴ Natural PP Floater Ball		Nat. PVDF	
4. Body ¹ – Floater Ball for Vent Valve ²	Black PP	Nat. PP	Red PVDF	Nat. PVDF
5. C.V. Seat-Carrier	Nat. PP		Nat. PVDF	
6. O-ring ³ Body & Carrier; End Seal	FKM			
7. O-ring ³ Seat-Carrier, OD Seal	FKM			
8. O-ring ³ Seat Seal	FKM			
9. Plain End Pipe Nipple for Flanged Valve	Black PP	Nat. PP	Red PVDF	Nat. PVDF
10. Flange–Socket for Flanged Valve	Black PP	Nat. PP	Red PVDF	Nat. PVDF

1 All components except valve bodies are available as replacement parts.

2 Gravity ball check valves are converted to vent valves by replacing the standard ball with a floater ball and inverting the valve at installation—with seat up.

3 Each replacement O-ring kit contains all the O-rings required to refurbish any True Union Check or Ball Valve (regardless of model or style), or a minimum of two pipe unions.

4 Polypropylene filled with glass micro-beads.

Dimensions¹–Weights–Fluid Flow Coefficients

Valve Size	Ball Check/Foot				Ball Check Valve					Seating Head Ft – H ₂ O		Fluid Flow Coefficient
	A	B	C	D	E Thd.	F Soc.	G Soc.	H Flgd.	Approx. ² Wt. Lbs.	Vert.	Horiz.	C _v ³
1/2	3.50	1.98	2.63	0.50	3.94	4.13	2.36	6.27	0.42	6	7	5
3/4	3.88	2.44	2.63	0.75	4.65	5.02	3.00	7.38	0.72	6	7	10
1	4.26	2.83	3.63	1.00	5.08	5.40	3.12	7.99	1.05	4	5	19
1 1/2	5.00	4.08	5.50	1.50	6.38	6.99	4.21	10.18	2.62	4	5	56
2	6.00	5.23	5.50	2.00	7.36	8.02	4.99	11.45	4.76	4	5	101

1 Dimensions shown are for PVC and CPVC. Due to molding shrinkage the dimensions for PP and PVDF would be somewhat less, and the end-to-end length of threaded equals socket valves.

2 Weights shown for ball valve figures are PVC threaded models. For an approximation of PVDF, and PP check valve weights the PVC weight may be multiplied by factors of 1.275, or 0.656 respectively.

3 C_v values are based on the basic valve laying length (G).

Kynar® is a registered trademark of Arkema Inc.

WARNING: DO NOT USE OR TEST THE PRODUCTS IN THIS CATALOG WITH COMPRESSED AIR OR OTHER GASES. FAILURE TO FOLLOW THIS WARNING CAN RESULT IN PERSONAL INJURY OR DAMAGE TO PROPERTY.

Revision 9/23/2013

Bench-Mount Fusion Machines

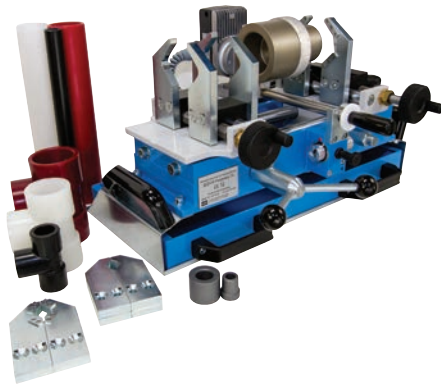

The bench-mount socket fusion machine is designed to join polypropylene and Kynar® PVDF IPS piping systems. Each machine, Models 7511XT, 3511, and 3600, is sized and specified to handle a particular range of IPS pipe sizes. Two clamps hold the pipe and one clamp holds the corresponding fitting or valve end connector in the precise position for socket fusion. Detailed operating instructions are found in the *Chemtrol Thermoplastic Piping Technical Manual*.

The basic machine comes in a steel or wood shipping crate with the heating tool, wrench, fixtures, clamping unit, and joining instructions. **The Socket Heat Face Sets are ordered separately.**

1/2" - 6" Benchmount Fusion Tools

MODEL NO.	SIZE RANGE	SIZE (W x D x H) HANDLE DOWN	WEIGHT (LBS.) W/CASE	VOLTS	PHASE	WATTS
7511XT	*1/2" – 2"	23 x 18 x 12.5	95.5	110 (+/- 10%)	Single	630
3511	1/2" – 4"	32 x 24 x 19	181.5	110 (+/- 10%)	Single	1200
3600	4" – 6"	42 x 28 x 19	302	220 (+/- 10%)	Single	1200

*7511XT machine does not fit 1-1/2" and 2" flanges.

Hand Held Fusion Tool - Multi-Size Joining Kits



Each kit contains all of the components required for joining all sizes of socket fusion connections specified for that kit, including: heating tool, male and female heat face sets with bolts, depth gages, cold ring pipe clamp with inserts, pipe cutter, beveling tool, timer, thermal blanket, auxiliary handle, hex key wrenches, thermostat adjustment tool, joining instructions and rugged heavy duty tool box.

Multiple Size Joining Kits 1/2" - 2" or 3" - 4"

MODEL NO.	SIZE RANGE	VOLTS	PHASE	WATTS
C168860	1/2" - 2"	110 (+/- 10%)	Single	800
C169060	3" - 4"	110 (+/- 10%)	Single	1650

Black & Chem-Pure® Natural Polypropylene

Couplings	15
Adapters	15
Elbows	16
Tees	17
Plugs	17
Caps	18
Bushings	18
Class 150 Flanges	19
Unions	20
Nipples	21

Kynar® Red and Natural PVDF

Couplings	22
Adapters	22
Elbows	22
Tees	23
Plugs	24
Caps	24
Bushings	24
Class 150 Flanges	25
Unions	26
Nipples	27

Kynar® is a registered trademark of Arkema Inc.

Fitting Terms and Abbreviations Schedule 80 only

FPT Female Pipe Thread
CL Close
MPT Male Pipe Thread
S Female Socket
SH Short
SPG Male End (Spigot)

Dimensions and Standards

Universal Part No.

XX XX - XXX

① ② ④

Chemtrol Part No.

(Discontinued)

XX XXX XXX

① ② ④

Material and Product Type

Product Line	① Universal Part Number	① Chemtrol Part Number	① Chemtrol Figure Number
PVC Sch. 80	8	01	45
CPVC Sch. 80	18	05	51
PP Black Sch. 80.	28	07	61
Sch. 80	78	10	62
PVDF Red Sch. 80	38	58	65
NPVDF Natural Sch. 80	48	06	66

Fitting Description

Fitting & End Connection	② Universal Part No.	② Chemtrol Part No.	② Chemtrol Fitting	③ Chemtrol Figure No. Connection(s)
Tee-Socket	01	013	00	Blank
Tee-Socket x Thread	02	015	12	Blank
Tee-Thread	05	014	12	3-3
90° ELL-Socket	06	001	07	Blank
90° ELL-Socket x Thread	07	003	07	3
90° ELL-Thread	08	002	07	3-3
90° Street ELL-Male Thread x Socket	10	219	07	4
90° Street ELL-Male Thread x Thread	12	213	07	3-4
45° ELL-Socket	17	007	06	Blank
45° ELL-Thread	19	008	06	3-3
Coupling-Socket	29	025	01	Blank
Coupling-Thread	30	026	01	3-3
Adapter Coupling-Socket x Thread	35	027	03	Blank
Male Adapter-Male Thread x Socket	36	217	04	Blank
Reducing Bushing-Socket	37	049	18	Blank
Reducing Bushing-Spigot x Thread	38	051	18	3
Reducing Bushing-Thread	39	050	18	3-4
Cap-Socket	47	031	17	Blank
Cap-Thread	48	032	17	3
Plug-Spigot	49	042	16	Blank
Plug-Thread	50	043	16	4
Flange-Socket	51	045	51	Blank
Flange-Thread	52	044	51	3
Flange-Blind	53	046	19	Blank
Van Stone Flange-Socket	54	069	51	A
Union-Socket	97	028	33	Blank
Union-Thread	98	029	33	3-3
Nipple-Thread x Thread	61	053	29	Blank

Chemtrol Figure

XX XX - X - X - SIZE

① ② ③ ④

Size Description	④ Universal Part Number	④ Chemtrol Part Number	④ Chemtrol Figure Number
Size			
1/4	002	004	Simply State Size
1/2	005	007	
3/4	007	008	
1	010	009	
1 1/4	012	010	
1 1/2	015	011	
2	020	012	
2 1/2	025	013	
3	030	014	
4	040	016	
6	060	018	
8	080	019	
10	100	020	
12	120	021	
1/2 x 1/4	072	027	
3/4 x 1/4	098	029	
3/4 x 1/2	101	031	
1 x 1/4	128	032	
1 x 1/2	130	034	
1 x 3/4	131	035	
1 1/4 x 1/2	166	038	
1 1/4 x 3/4	167	039	
1 1/4 x 1	168	040	
1 1/2 x 1/2	209	043	
1 1/2 x 3/4	210	044	
1 1/2 x 1	211	045	
1 1/2 x 1 1/4	212	046	
2 x 1/2	247	049	
2 x 3/4	248	050	
2 x 1	249	051	
2 x 1 1/4	250	052	
2 x 1 1/2	251	053	
2 1/2 x 1/2	287	056	
2 1/2 x 3/4	288	057	
2 1/2 x 1	289	058	
2 1/2 x 1 1/4	290	059	
2 1/2 x 1 1/2	291	060	
2 1/2 x 2	292	061	
3 x 1	335	066	
3 x 1 1/4	336	067	
3 x 1 1/2	337	068	
3 x 2	338	069	
3 x 2 1/2	339	069	
4 x 2	420	076	
4 x 2 1/2	421	077	
4 x 3	422	078	
6 x 2	528	082	
6 x 3	530	084	
6 x 4	532	085	
8 x 6	585	088	

Couplings

Chemtrol
Fig. No.

6101/6201 Socket Couplings (S x S)

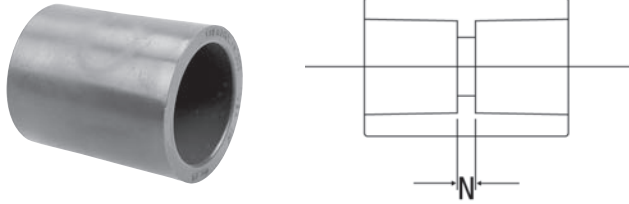

Nominal Size	Universal Part No.		Ctn. Qty.	Approx. Lbs./Ea.	Dim. N
	Black	Chem-Pure			
1/2	2829-005	7829-005	10	0.06	0.29
3/4	2829-007	7829-007	10	0.08	0.29
1	2829-010	7829-010	10	0.13	0.28
1 1/2	2829-015	7829-015	10	0.22	0.28
2	2829-020	7829-020	10	0.35	0.27
3	2829-030	7829-030	5	0.60	0.24
4	2829-040	7829-040	5	1.01	0.22
6	2829-060	—	2	2.37	0.26

6101-3-3/6201-3-3 Thread* Coupling (FPT x FPT)

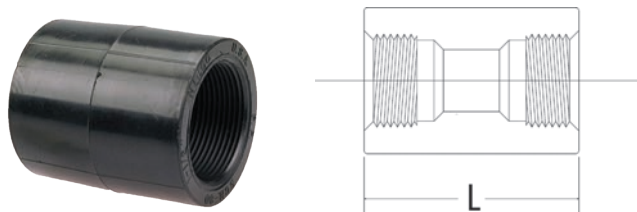

Nominal Size	Universal Part No.		Ctn. Qty.	Approx. Lbs./Ea.	Dim. L
	Black	Chem-Pure			
1/2	2830-005	7830-005	10	0.06	1.99
3/4	2830-007	7830-007	10	0.09	2.24
1	2830-010	7830-010	10	0.14	2.48
1 1/4	2830-012	7830-012	10	0.19	2.73
1 1/2	2830-015	7830-015	10	0.26	2.98
2	2830-020	7830-020	10	0.35	3.22
3	2830-030	7830-030	5	0.73	3.93
4	2830-040	7830-040	5	1.21	4.66

*Recommended for intermittent service not exceeding 20 psi.

Adapters

Chemtrol
Fig. No.

6103/6203 Female Adapter Coupling (S x FPT*)

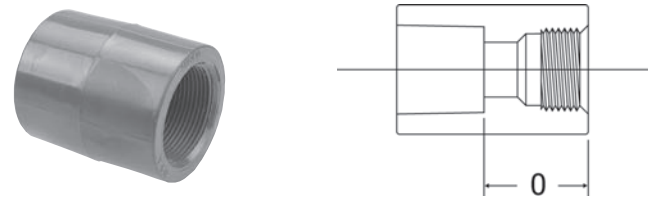

Nominal Size	Universal Part No.		Ctn. Qty.	Approx. Lbs./Ea.	Dim. O
	Black	Chem-Pure			
1/2	2835-005	7835-005	10	0.06	1.14
3/4	2835-007	7835-007	10	0.08	1.26
1	2835-010	7835-010	10	0.13	1.38
1 1/2	2835-015	7835-015	10	0.24	1.63
2	2835-020	7835-020	10	0.34	1.75
3	2835-030	7835-030	5	0.65	2.08
4	2835-040	7835-040	5	1.16	2.44

*Recommended for intermittent service not exceeding 20 psi.

6150 Tank Adapter (Tank x FPT*)



Nom. Size	Part No.	Ctn. Qty.	Approx. Lbs./Ea.	Dim. A	Dim. Or	Dim. Do
3/4	Figure	5	0.30	14npt	1.19	1.63
1	No. &	5	0.31	11 1/2npt	1.38	2.50
1 1/4	Nom. Size	5	0.35	11 1/2npt	1.38	2.50
1 1/2		5	0.39	11 1/2npt	1.38	2.50
2		5	0.52	11 1/2npt	1.56	3.13
3		5	0.81	8npt	1.75	4.25

*Recommended for intermittent service not exceeding 20 psi.

Note: 1. Gasket is EPDM

For questions concerning thermoplastic piping systems, please call or fax: **888.446.4226 (ph)**, **888.336.4226 (fx)**.

Elbows

Chemtrol
Fig. No.

6107/6207 Socket 90° Elbow (S x S)

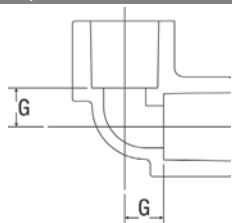

Nominal Size	Universal Part No.		Ctn. Qty.	Approx. Lbs./Ea.	Dim. G
	Black	Chem-Pure			
1/2	2806-005	7806-005	10	0.06	0.53
3/4	2806-007	7806-007	10	0.08	0.70
1	2806-010	7806-010	10	0.15	0.76
1 1/2	2806-015	7806-015	10	0.32	1.06
2	2806-020	7806-020	10	0.49	1.25
3	2806-030	7806-030	5	1.14	1.83
4	2806-040	7806-040	5	1.93	2.32
6	2806-060	—	2	4.47	3.44

6107-3-3/6207-3-3 Thread* 90° Elbow (FPT x FPT)

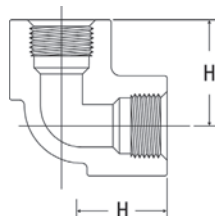

Nominal Size	Universal Part No.		Ctn. Qty.	Approx. Lbs./Ea.	Dim. H
	Black	Chem-Pure			
1/2	2808-005	7808-005	10	0.07	1.38
3/4	2808-007	7808-007	10	0.11	1.67
1	2808-010	7808-010	10	0.16	1.86
1 1/4	2808-012	7808-012	10	0.25	2.14
1 1/2	2808-015	7808-015	10	0.33	2.41
2	2808-020	7808-020	10	0.49	2.73
3	2808-030	7808-030	5	1.12	3.67
4	2808-040	7808-040	5	2.02	4.54

*Recommended for intermittent service not exceeding 20 psi.

Chemtrol
Fig. No.

6106/6206 Socket 45° Elbow (S x S)

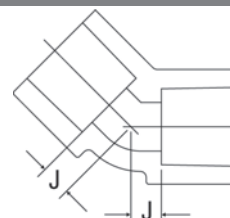

Nominal Size	Universal Part No.		Ctn. Qty.	Approx. Lbs./Ea.	Dim. J
	Black	Chem-Pure			
1/2	2817-005	7817-005	10	0.06	0.28
3/4	2817-007	7817-007	10	0.08	0.35
1	2817-010	7817-010	10	0.14	0.38
1 1/2	2817-015	7817-015	10	0.25	0.48
2	2817-020	7817-020	10	0.37	0.61
3	2817-030	7817-030	5	0.80	0.79
4	2817-040	7817-040	5	1.54	1.02
6	2817-060	—	2	3.55	1.72

6106-3-3/6206-3-3 Thread* 45° Elbow (FPT x FPT)

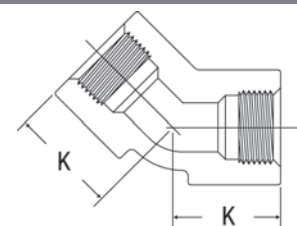

Nominal Size	Universal Part No.		Ctn. Qty.	Approx. Lbs./Ea.	Dim. K
	Black	Chem-Pure			
1/2	2819-005	7819-005	10	0.06	1.13
3/4	2819-007	7819-007	10	0.11	1.32
1	2819-010	7819-010	10	0.15	1.48
1 1/4	2819-012	7819-012	10	0.21	1.66
1 1/2	2819-015	7819-015	10	0.30	1.83
2	2819-020	7819-020	10	0.42	2.09
3	2819-030	7819-030	5	0.92	2.64
4	2819-040	7819-040	5	1.62	3.24

*Recommended for intermittent service not exceeding 29 psi.

For questions concerning thermoplastic piping systems, please call or fax: **888.446.4226 (ph)**, **888.336.4226 (fx)**.

Tees

Chemtrol
Fig. No.

6111/6211 Socket Tee (S x S x S)

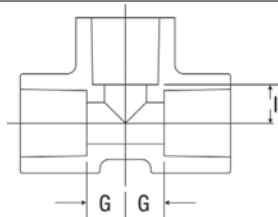

Nominal Size	Universal Part No.		Ctn. Qty.	Approx. Lbs./Ea.	Dim. G	Dim. I
	Black	Chem-Pure				
1/2	2801-005	7801-005	10	0.09	0.53	0.53
3/4	2801-007	7801-007	10	0.14	0.70	0.70
1	2801-010	7801-010	10	0.19	0.76	0.76
1 1/2	2801-015	7801-015	10	0.43	1.06	1.06
2	2801-020	7801-020	10	1.69	1.25	1.25
3	2801-030	7801-030	5	1.43	1.83	1.83
4	2801-040	7801-040	5	2.41	2.32	2.32
6	2801-060	—	2	5.71	3.44	3.44

6112-3-3/6212-3-3 Thread* Tee (FPT x FPT x FPT)

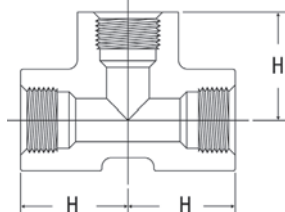

Nominal Size	Universal Part No.		Ctn. Qty.	Approx. Lbs./Ea.	Dim. H
	Black	Chem-Pure			
1/2	2805-005	7805-005	10	0.10	1.38
3/4	2805-007	7805-007	10	0.16	1.67
1	2805-010	7805-010	10	0.24	1.86
1 1/4	2805-012	7805-012	10	0.35	2.14
1 1/2	2805-015	7805-015	10	0.46	2.41
2	2805-020	7805-020	10	0.67	2.73
3	2805-030	7805-030	5	1.54	3.67
4	2805-040	7805-040	5	1.97	4.54

* Recommended for intermittent service not exceeding 20 psi.

Plugs

Chemtrol
Fig. No.

6116-4/6216-4 Thread* Plug (MPT)

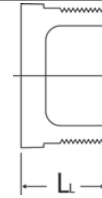

Nominal Size	Universal Part No.		Ctn. Qty.	Approx. Lbs./Ea.	Dim. L
	Black	Chem-Pure			
1/2	2850-005	7850-005	10	0.02	1.15
3/4	2850-007	7850-007	10	0.02	1.27
1	2850-010	7850-010	10	0.04	1.53
1 1/4	2850-012	7850-012	5	0.13	1.57
1 1/2	2850-015	7850-015	5	0.16	1.55
2	2850-020	7850-020	5	0.25	1.55
3	2850-030	7850-030	5	0.33	2.38
4	2850-040	7850-040	5	0.66	2.76

* Recommended for intermittent service not exceeding 20 psi.

For questions concerning thermoplastic piping systems, please call or fax: **888.446.4226 (ph)**, **888.336.4226 (fx)**.

Caps

Chemtrol
Fig. No.

6117/6217 Socket Cap† (S)

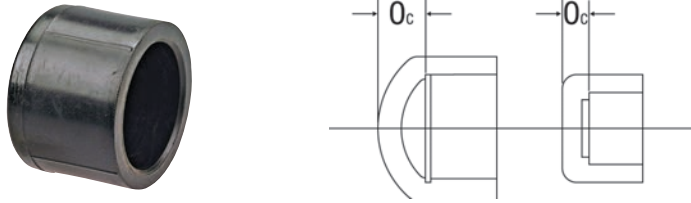

Nominal Size	Universal Part No. Black	Chem-Pure	Ctn. Qty.	Approx. Lbs./Ea.	Dim. Oc
1/2	2847-005	7847-005	10	0.04	0.41
3/4	2847-007	7847-007	10	0.05	0.38
1	2847-010	7847-010	10	0.09	0.42
1 1/2	2847-015	7847-015	10	0.17	0.42
2	2847-020	7847-020	10	0.23	0.42
3	2847-030	7847-030	5	0.52	1.29
4	2847-040	7847-040	5	0.90	1.57
6	2847-060	—	2	2.08	2.04

† Sizes 2" and smaller are flat; 3" and larger are domed.

6117-3/6217-3 Thread* Cap† (FPT)

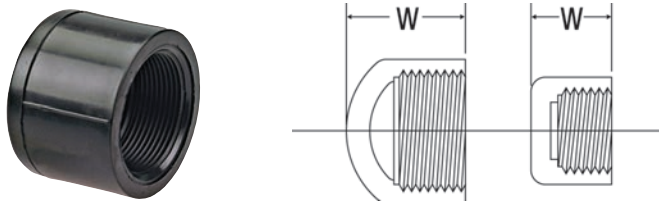

Nominal Size	Universal Part No. Black	Chem-Pure	Ctn. Qty.	Approx. Lbs./Ea.	Dim. W
1/2	2848-005	7848-005	10	0.04	1.26
3/4	2848-007	7848-007	10	0.08	1.36
1	2848-010	7848-010	10	0.09	1.52
1 1/4	2848-012	7848-012	10	0.13	1.63
1 1/2	2848-015	7848-015	10	0.19	1.77
2	2848-020	7848-020	10	0.26	1.90
3	2848-030	7848-030	5	0.58	3.13
4	2848-040	7848-040	5	1.02	3.79

* Recommended for intermittent service not exceeding 20 psi.

† Sizes 2" and smaller are flat; 3" and larger are domed.

Bushings

Chemtrol
Fig. No.

6118/6218 Flush Socket Reducer Bushing (SPG x S)

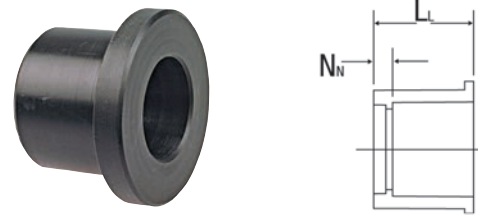

Nominal Size	Universal Part No. Black	Chem-Pure	Ctn. Qty.	Approx. Lbs./Ea.	Design Style†	Dim. L _L	Dim. N _N
3/4 x 1/2	2837-101	7837-101	10	0.02	S	1.28	0.43
1 x 1/2	2837-130	7837-130	10	0.04	S	1.53	0.68
1 x 3/4	2837-131	7837-131	10	0.03	S	1.53	0.56
1 1/2 x 1	2837-211	7837-211	10	0.10	S	1.78	0.68
2 x 1	2837-249	7837-249	10	0.18	S	1.91	0.81
2 x 1 1/2	2837-251	7837-251	10	0.12	S	1.91	0.56
3 x 2	2837-338	7837-338	5	0.42	S	2.38	0.90
4 x 3	2837-422	7837-422	5	0.62	S	2.76	0.91
6 x 4	2837-532	—	2	1.74	S	3.00	0.78

Note: 3" and 4" sizes are hex head; 3/4", 1", 1 1/2", 2", and 6" have round heads.

† All Bushings have solid walls.

6118-3-4/6218-3-4 Flush Thread* Reducer Bushing (MPT x FPT)

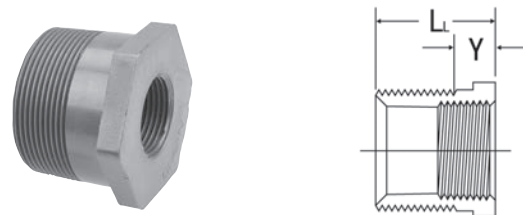

Nominal Size	Universal Part No. Black	Chem-Pure	Ctn. Qty.	Approx. Lbs./Ea.	Design Style†	Dim. L _L	Dim. Y**
3/4 x 1/2	2839-101	7839-101	10	0.02	S	1.27	0.43
1 x 1/2	2839-130	7839-130	10	0.04	S	1.53	0.43
1 x 3/4	2839-131	7839-131	10	0.03	S	1.53	0.45
1 1/4 x 3/4	2839-167	7839-167	10	0.09	S	1.38	0.45
1 1/4 x 1	2839-168	7839-168	10	0.07	S	1.38	0.53
1 1/2 x 1	2839-211	7839-211	10	0.11	S	1.55	0.53
1 1/2 x 1 1/4	2839-212	7839-212	10	0.07	S	1.55	0.55
2 x 1	2839-249	7839-249	10	0.18	S	1.57	0.53
2 x 1 1/2	2839-251	7839-251	10	0.13	S	1.57	0.55
3 x 2	2839-338	7839-338	5	0.38	S	2.38	0.57
4 x 3	2839-422	7839-422	5	0.49	S	2.76	0.95

* Recommended for intermittent service not exceeding 20 psi.

** Typical male component engagement, hand tight (L_L in ANSI B1.20.1 thread spec.) plus 1 1/2 turns.

Note: 3/4", 1", 3", and 4" sizes are hex head; 1 1/4", 1 1/2", and 2" are knurled round.

† All Bushings have solid walls.

Class 150 Flanges

For flange dimensions that comply with ANSI B16.5, 150 lb., steel flanges, see page 37.

Chemtrol
Fig. No.

6151-H/6251-H Socket Flange (S), One-Piece (Solid)

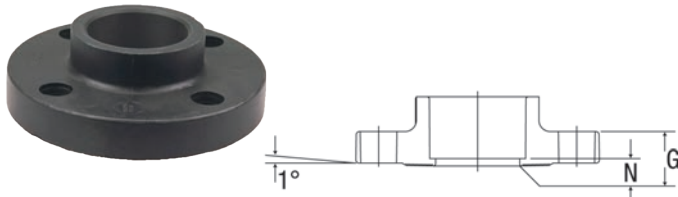

Nominal Size	Universal Part No. Black	Chem-Pure	Ctn. Qty.	Approx. Lbs./Ea.	Dim. G	Dim. N
1/2	2851-H05	7851-H05	10	0.13	0.54	0.23
3/4	2851-H07	7851-H07	10	0.20	0.60	0.20
1	2851-H10	7851-H10	10	0.24	0.67	0.21
1 1/2	2851-H15	7851-H15	10	0.41	0.72	0.23
2	2851-H20	7851-H20	10	0.79	0.90	0.27
3	2851-H30	7851-H30	5	1.50	1.12	0.34
4	2851-H40	7851-H40	5	2.20	1.23	0.33
6	2851-H60	—	2	3.45	1.33	0.28

6151-H-3/6251-H-3 Thread* Flange (FPT), One-Piece (Solid)

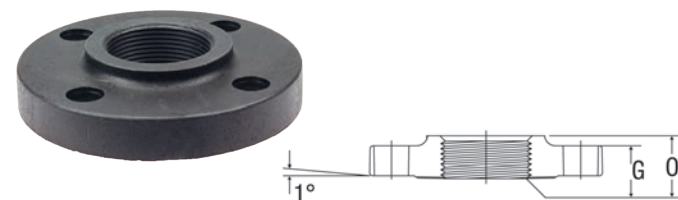

Nominal Size	Universal Part No. Black	Chem-Pure	Ctn. Qty.	Approx. Lbs./Ea.	Dim. G	Dim. O _F
1/2	2852-H05	7852-H05	10	0.13	0.54	0.87
3/4	2852-H07	7852-H07	10	0.18	0.60	0.90
1	2852-H10	7852-H10	10	0.24	0.67	1.07
1 1/4	2852-H12	7852-H12	5	0.34	0.65	1.11
1 1/2	2852-H15	7852-H15	5	0.39	0.72	1.07
2	2852-H20	7852-H20	5	0.71	0.90	1.17
3	2852-H30	7852-H30	5	1.22	1.12	1.53
4	2852-H40	7852-H40	5	2.03	1.23	1.65

* Recommended for intermittent service not exceeding 20 psi.

Chemtrol
Fig. No.

6119-H/6219-H Blind Flange, One-Piece (Solid)

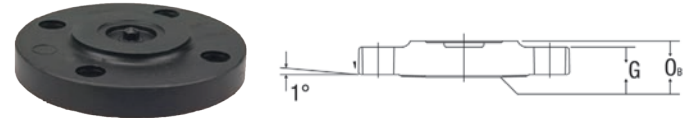

Nominal Size	Universal Part No. Black	Chem-Pure	Ctn. Qty.	Approx. Lbs./Ea.	Dim. G	Dim. O _B
1/2	2853-H05	7853-H05	10	0.13	0.54	0.75
3/4	2853-H07	7853-H07	10	0.20	0.60	0.82
1	2853-H10	7853-H10	10	0.26	0.67	0.87
1 1/4	2853-H12	—	10	0.32	0.65	0.89
1 1/2	2853-H15	7853-H15	10	0.39	0.72	0.98
2	2853-H20	7853-H20	5	0.82	0.90	1.11
3	2853-H30	7853-H30	5	1.74	1.12	1.37
4	2853-H40	7853-H40	5	2.70	1.23	1.49
6	2853-H60	—	2	4.28	1.33	1.53

6151-W/6251-W Socket Flange (S), One-Piece (Webbed Design)

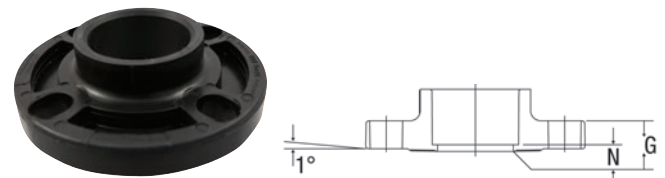

Nominal Size	Universal Part No. Black	Chem-Pure	Ctn. Qty.	Approx. Lbs./Ea.	Dim. G	Dim. N
2	2851-020	7851-020	10	0.61	0.90	0.27
3	2851-030	7851-030	5	1.16	1.12	0.34
4	2851-040	7851-040	5	1.69	1.23	0.33
6	2851-060	7851-060	2	2.66	1.33	0.28

Note: One-piece webbed flanges have oblong bolt holes which permit mating with ANSI B16.5, 150 lb.; BS 1560, class 150; ISO 2084, PN10; and DIN 2532, PN10 flanges.

6151-W-3/6251-W-3 Thread* Flange (FPT), One-Piece (Webbed Design)

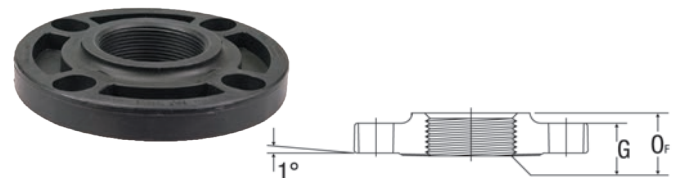

Nominal Size	Universal Part No. Black	Chem-Pure	Ctn. Qty.	Approx. Lbs./Ea.	Dim. G	Dim. O _F
2	2852-020	7852-020	5	0.56	0.90	1.17
3	2852-030	7852-030	5	0.98	1.12	1.53
4	2852-040	7852-040	5	1.62	1.23	1.65

* Recommended for intermittent service not exceeding 20 psi.

Note: One-piece webbed flanges have oblong bolt holes which permit mating with ANSI B16.5, 150 lb.; BS 1560, class 150; ISO 2084, PN10; and DIN 2532, PN10 flanges.

6119-W Blind Flange, One-Piece (Webbed Design)

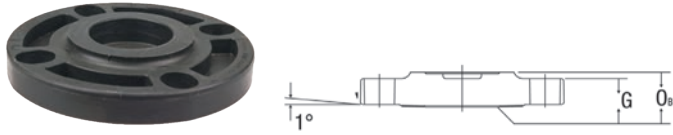

Nominal Size	Universal Part No.	Ctn. Qty.	Approx. Lbs./Ea.	Dim. G	Dim. O _B
2	2853-020	5	0.59	0.90	1.11
3	2853-030	5	1.14	1.12	1.37
4	2853-040	5	1.94	1.23	1.49
6	2853-060	2	3.08	1.33	1.53

Note: One-piece webbed flanges have oblong bolt holes which permit mating with ANSI B16.5, 150 lb.; BS 1560, class 150; ISO 2084, PN10; and DIN 2532, PN10.

Chemtrol
Fig. No.

Flanged Fittings*– Fabricated from Molded Components

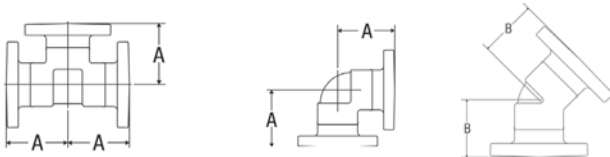

Nominal Size	Flanged Tee		Flanged 90° ELL		Flanged 45° ELL	
	Approx. Lbs./Ea.	Dim. A	Approx. Lbs./Ea.	Dim. A	Approx. Lbs./Ea.	Dim. B
1/2	0.24	2 13/32	0.21	2 13/32	0.21	2 5/32
3/4	0.37	2 23/32	0.31	2 23/32	0.31	2 15/32
1	0.48	3 3/32	0.44	3 3/32	0.43	2 23/32
1 1/2	0.94	3 31/32	0.83	3 31/32	0.76	3 13/32
2	1.64	5 7/32	1.44	4 15/32	1.32	3 27/32
3	4.97	5 15/32	3.04	5 13/32	2.70	4 25/32
4	5.30	7 3/32	4.82	7 3/32	4.43	5 25/32

*Flanged fittings are produced by heat fusion of socket flanges to socket fittings with short plain end pipe nipples.

NR 51 Flange Gaskets, for Class 150 Flanges

Note: These gaskets are 1/8" thick, full face polychloroprene (CR), 70 durometer.



Nominal Size	Part No.	Approx. Lbs./Ea.
1/2	↑ Use Figure No. & Nom. Size ↓	0.11
3/4		0.12
1		0.13
1 1/4		0.14
1 1/2		0.15
2		0.20
2 1/2		0.25
3		0.28
4	0.30	
6	0.40	
8	0.50	

Unions

Chemtrol
Fig. No.

6133/6233 FKM Socket Union (S x S)



Nominal Size	Universal Black	Part No. Chem-Pure	Ctn. Qty.	Approx. Lbs./Ea.	Dim. A	Dim. L	Dim. S*
1/2	2897-005	7897-005	10	0.11	1.98	0.46	0.85
3/4	2897-007	7897-007	10	0.20	2.41	0.50	0.98
1	2897-010	7897-010	10	0.28	2.77	0.48	1.10
1 1/2	2897-015	7897-015	5	0.70	4.04	0.79	1.35
2	2897-020	7897-020	5	1.31	5.20	0.82	1.48

Unions are supplied with FKM O-Rings. EPDM O-Rings may be ordered for field replacement, where required. Socket x Thread is available on request. Threaded fittings are recommended for intermittent service not exceeding 20 psi.

* Socket Depth

6133-3-3/6233-3-3 FKM Threaded* Union (FPT x FPT)

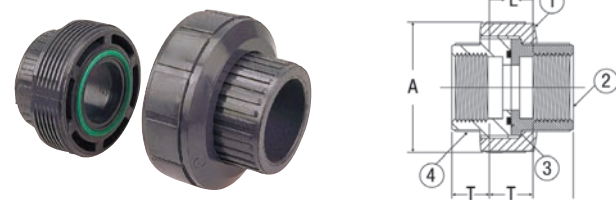

Nominal Size	Universal Black	Part No. Chem-Pure	Ctn. Qty.	Approx. Lbs./Ea.	Dim. A	Dim. L	Dim. T**
1/2	2898-005	7898-005	10	0.12	1.17	1.30	0.43
3/4	2898-007	7898-007	10	0.20	2.41	1.55	0.45
1	2898-010	7898-010	10	0.29	2.77	1.62	0.53
1 1/4	2898-012	7898-012	5	0.67	4.04	2.17	0.55
1 1/2	2898-015	7898-015	5	0.74	4.04	2.39	0.55
2	2898-020	7898-020	5	1.39	5.20	2.63	0.57

Unions are supplied with FKM O-Rings. EPDM O-Rings may be ordered for field replacement, where required. Socket x Thread is available on request.

* Recommended for intermittent service not exceeding 20 psi.

** Thread Joint Engagement

*Chemtrol sells its products through a select group of highly trained distributors. Please call **800.343.5455** for a listing of distributors in your area.*

Nipples

6129 Threaded* Pipe Nipple (MPT x MPT)

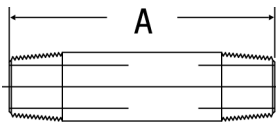

Length – 2"

Nom. Size	Ctn. Qty.	Approx. Lbs./Ea.
1/2	10	0.02

Example of part identification
1/2" x Short PP Nipple – 6129 1/2" – SH

Nom. Size	Length – Close			Length – Short			Length – 3"		
	Ctn. Qty.	Approx. Lbs./Ea.	Dim. A	Ctn. Qty.	Approx. Lbs./Ea.	Dim. A	Ctn. Qty.	Approx. Lbs./Ea.	Dim. A
1/2	10	0.01	1.13	10	0.01	1.50	10	0.03	
3/4	10	0.02	1.38	10	0.03	2.00	10	0.04	
1	10	0.03	1.50	10	0.04	2.00	10	0.06	
1 1/4	10	0.04	1.63	10	0.06	2.50	10	0.08	
1 1/2	10	0.06	1.75	10	0.08	2.50	10	0.10	
2	10	0.09	2.00	10	0.11	2.50	10	0.14	
3	5	0.21	2.63	5	0.26	3.00	See Short		
4	5	0.35	2.88	5	0.50	4.00	See Close		

Nom. Size	Length – 4"		Length – 5"		Length – 6"	
	Ctn. Qty.	Approx. Lbs./Ea.	Ctn. Qty.	Approx. Lbs./Ea.	Ctn. Qty.	Approx. Lbs./Ea.
1/2	10	0.04	10	0.05	10	0.06
3/4	10	0.06	10	0.07	10	0.09
1	10	0.08	10	0.10	10	0.12
1 1/4	10	0.12	10	0.14	10	0.18
1 1/2	10	0.14	10	0.18	10	0.21
2	10	0.20	10	0.24	10	0.30
3	5	0.37	5	0.46	5	0.59
4	See Short		5	0.72	5	0.85

*Recommended for intermittent service not exceeding 20 psi.

Chemtrol
Fig. No.

6131 Plain End Pipe Nipple (SPG x SPG)

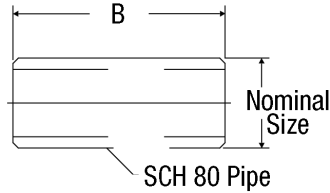

Used for joining any
Sch. 80 Polypropylene
fitting face-to-face.

Nominal Size	Part Number	Ctn. Qty.	Approx. Lbs./Ea.	Dim. B
1/2	Use Figure No. & Nom. Size	6	0.02	1.62
3/4		10	0.03	2.86
1		10	0.05	2.08
1 1/2		10	0.10	2.56
2		10	0.16	2.77
3		6	0.40	3.48
4	6	0.69	4.26	
6	3	1.80	5.70	

Couplings

6501/6601 Socket Coupling (S x S)

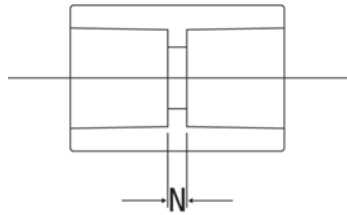

Nominal Size	Universal Part No.		Ctn. Qty.	Approx. Lbs./Ea.	Dim. N
	Red	Natural			
1/2	3829-005	4829-005	5	0.12	0.28
3/4	3829-007	4829-007	5	0.16	0.27
1	3829-010	4829-010	5	0.26	0.26
1 1/2	3829-015	4829-015	2	0.49	0.25
2	3829-020	4829-020	2	0.71	0.24
3	3829-030	4829-030	2	1.43	0.21
4	3829-040	4829-040	2	2.47	0.19
6	3829-060	4829-060	1	5.49	0.21

6501-3-3/6601-3-3 Thread Coupling (FPT x FPT)

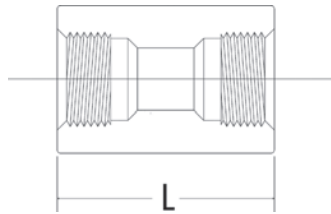

Nominal Size	Universal Part No.		Ctn. Qty.	Approx. Lbs./Ea.	Dim. L
	Red	Natural			
1/2	3830-005	4830-005	5	0.12	1.98
3/4	3830-007	4830-007	5	0.16	2.22
1	3830-010	4830-010	5	0.56	2.46
1 1/2	3830-015	4830-015	2	0.49	2.95
2	3830-020	4830-020	2	0.71	3.19

Adapters

Chemtrol
Fig. No.

6503/6603 Female Adapter Coupling (S x FPT)

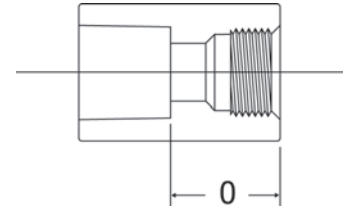

Nominal Size	Universal Part No.		Ctn. Qty.	Approx. Lbs./Ea.	Dim. O
	Red	Natural			
1/2	3835-005	4835-005	5	0.12	1.13
3/4	3835-007	4835-007	5	0.16	1.25
1	3835-010	4835-010	5	0.26	1.36
1 1/2	3835-015	4835-015	2	0.49	1.60
2	3835-020	4835-020	2	0.71	1.72

Elbows

6507/6607 Socket 90° Elbow (S x S)

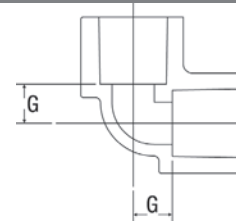

Nominal Size	Universal Part No.		Ctn. Qty.	Approx. Lbs./Ea.	Dim. G
	Red	Natural			
1/2	3806-005	4806-005	5	0.12	0.52
3/4	3806-007	4806-007	5	0.18	0.69
1	3806-010	4806-010	5	0.28	0.74
1 1/2	3806-015	4806-015	2	0.56	1.04
2	3806-020	4806-020	2	0.95	1.23
3	3806-030	4806-030	2	2.51	1.80
4	3806-040	4806-040	2	4.02	2.28
6	3806-060	4806-060	1	9.76	3.39

For complete technical information and more, refer to our website at www.chemtrol.com.

Elbows

Chemtrol
Fig. No.

6507-3-3/6607-3-3 Thread 90° Elbow (FPT x FPT)

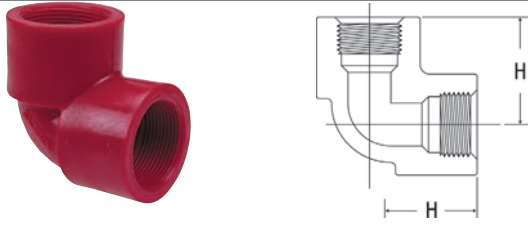

Nominal Size	Universal Part No.		Ctn. Qty.	Approx. Lbs./Ea.	Dim. H
	Red	Natural			
1/2	3808-005	4808-005	5	0.13	1.37
3/4	3808-007	4808-007	5	0.20	1.60
1	3808-010	4808-010	5	0.32	1.84
1 1/2	3808-015	4808-015	2	0.64	2.39
2	3808-020	4808-020	2	0.80	2.71

6506/6606 Socket 45° Elbow (S x S)

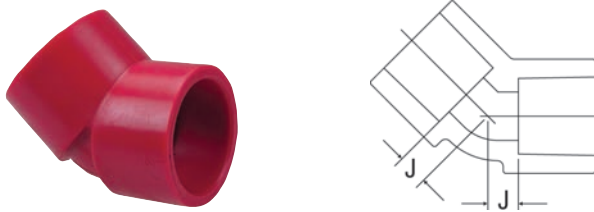

Nominal Size	Universal Part No.		Ctn. Qty.	Approx. Lbs./Ea.	Dim. J
	Red	Natural			
1/2	3817-005	4817-005	5	0.10	0.27
3/4	3817-007	4817-007	5	0.14	0.33
1	3817-010	4817-010	5	0.29	0.37
1 1/2	3817-015	4817-015	2	0.49	0.46
2	3817-020	4817-020	2	0.68	0.59
3	3817-030	4817-030	2	1.53	0.77
4	3817-040	4817-040	2	2.71	0.99
6	3817-060	4817-060	1	6.40	1.69

6506-3-3/6606-3-3 Thread 45° Elbow (FPT x FPT)

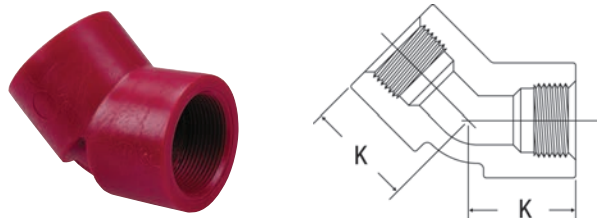

Nominal Size	Universal Part No.		Ctn. Qty.	Approx. Lbs./Ea.	Dim. K
	Red	Natural			
1/2	3819-005	4819-005	5	0.12	1.12
3/4	3819-007	4819-007	5	0.18	1.31
1	3819-010	4819-010	5	0.29	1.47
1 1/2	3819-015	4819-015	2	0.55	1.81
2	3819-020	4819-020	2	0.80	2.07

Tees

Chemtrol
Fig. No.

6511/6611 Socket Tee (S x S x S)

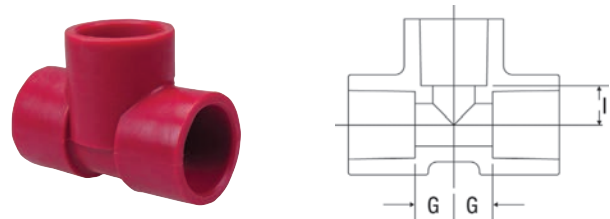

Nominal Size	Universal Part No.		Ctn. Qty.	Approx. Lbs./Ea.	Dim. G	Dim. I
	Red	Natural				
1/2	3801-005	4801-005	5	0.16	0.52	0.52
3/4	3801-007	4801-007	5	0.29	0.69	0.69
1	3801-010	4801-010	5	0.47	0.74	0.74
1 1/2	3801-015	4801-015	2	0.79	1.04	1.04
2	3801-020	4801-020	2	1.36	1.23	1.23
3	3801-030	4801-030	2	2.61	1.80	1.80
4	3801-040	4801-040	2	4.50	2.28	2.28
6	3801-060	4801-060	1	11.33	3.39	3.39

6512-3-3/6612-3-3 Thread Tee (FPT x FPT x FPT)

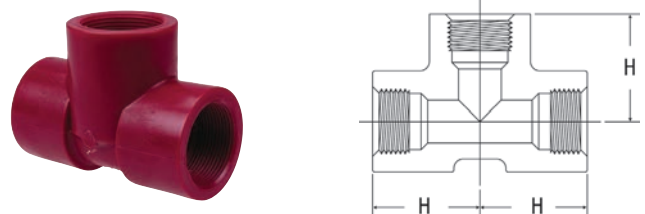

Nominal Size	Universal Part No.		Ctn. Qty.	Approx. Lbs./Ea.	Dim. H
	Red	Natural			
1/2	3805-005	4805-005	5	0.18	1.37
3/4	3805-007	4805-007	5	0.30	1.60
1	3805-010	4805-010	5	0.44	1.84
1 1/2	3805-015	4805-015	2	0.92	2.39
2	3805-020	4805-020	2	1.31	2.71

Kynar® is a registered trademark of Arkema Inc.

Plugs

Chemtrol
Fig. No.

6516-4/6616-4 Thread Plug (MPT)

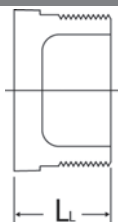

Nominal Size	Universal Part No.		Ctn. Qty.	Approx. Lbs./Ea.	Dim. L1
	Red	Natural			
1/2	3850-005	4850-005	5	0.03	1.14
3/4	3850-007	4850-007	5	0.08	1.26
1	3850-010	4850-010	5	0.10	1.48
1 1/2	3850-015	4850-015	2	0.18	1.78
2	3850-020	4850-020	2	0.26	1.89

Bushings

Chemtrol
Fig. No.

6518/6618 Flush Socket Reducer Bushing (SPG x S)

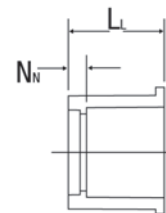

Nominal Size	Universal Part No.		Ctn. Qty.	Approx. Lbs./Ea.	Design Style*	Dim. L1	Dim. N1
	Red	Natural					
3/4 x 1/2	3837-101	4837-101	5	0.08	S	1.40	0.55
1 x 1/2	3837-130	4837-130	5	0.16	S	1.52	0.67
1 x 3/4	3837-131	4837-131	5	0.08	S	1.52	0.55
1 1/2 x 1	3837-249	4837-168	5	0.34	S	1.79	0.69
2 x 1	3837-249	4837-249	5	0.63	S	1.89	0.79
2 x 1 1/2	3837-251	4837-251	5	0.50	S	1.89	0.54
3 x 2	3837-338	4837-338	5	0.88	S	2.36	0.88
4 x 3	3837-422	4837-442	5	1.36	S	2.74	0.89
6 x 4	3837-532	4837-532	2	4.67	S	2.98	0.76

* All Bushings have solid walls.

6518-3-4/6618-3-4 Flush Thread Reducer Bushing (MPT x FPT)

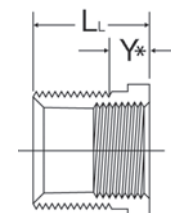

Nominal Size	Universal Part No.		Ctn. Qty.	Approx. Lbs./Ea.	Design Style	Dim. L1	Dim. Y*
	Red	Natural					
3/4 x 1/2	3839-101	4839-101	5	0.05	S	1.26	0.43
1 x 1/2	3839-130	4839-130	5	0.16	S	1.52	0.43
1 x 3/4	3839-131	4839-131	5	0.08	S	1.52	0.45
1 1/2 x 1	3839-211	4839-211	5	0.19	S	1.79	0.53
2 x 1	3839-249	4839-249	5	0.35	S	1.89	0.53
2 x 1 1/2	3839-251	4839-251	5	0.22	S	1.89	0.55

* Typical male component engagement, hand tight (L1 in ANSI B1.20.1 thread spec.) plus 1 1/2 turns plus.

** All Bushings have solid walls.

*For questions concerning thermoplastic piping systems, please call or fax: **888.446.4226 (ph)**, **888.336.4226 (fx)**.*

Caps

6517/6617 Socket Cap (S)

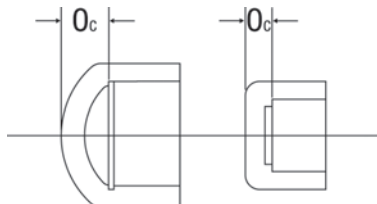

Nominal Size	Universal Part No.		Ctn. Qty.	Approx. Lbs./Ea.	Dim. Oc
	Red	Natural			
1/2	3847-005	4847-005	5	0.07	0.40
3/4	3847-007	4847-007	5	0.10	0.37
1	3847-010	4847-010	5	0.17	0.41
1 1/2	3847-015	4847-015	2	0.29	0.40
2	3847-020	4847-020	2	0.48	0.41

Note: Caps are flat top style.

6517-3/6617-3 Thread Cap (FPT)

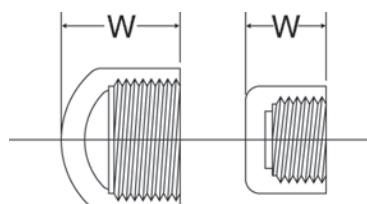

Nominal Size	Universal Part No.		Ctn. Qty.	Approx. Lbs./Ea.	Dim. W
	Red	Natural			
1/2	3848-005	4848-005	5	0.07	1.25
3/4	3848-007	4848-007	5	0.10	1.34
1	3848-010	4848-010	5	0.17	1.51
1 1/2	3848-015	4848-015	2	0.33	1.75
2	3848-020	4848-020	2	0.48	1.88

Class 150 Flanges

Chemtrol
Fig. No.

6551-H/6651-H Socket Flange (S), One-Piece (Solid)

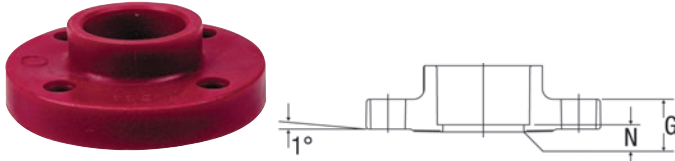

Nominal Size	Universal Part No.		Ctn. Qty.	Approx. Lbs./Ea.	Dim. G	Dim. N
	Red	Natural				
1/2	3851-H05	4851-H05	5	0.25	0.53	0.19
3/4	3851-H07	4851-H07	5	0.33	0.59	0.20
1	3851-H10	4851-H10	5	0.48	0.66	0.21
1 1/2	3851-H15	4851-H15	2	0.75	0.72	0.23
2	3851-H20	4851-H20	2	1.16	0.90	0.27
3	3851-H30	4851-H30	2	2.56	1.10	0.34
4	3851-H40	4851-H40	2	3.86	1.21	0.31
6	3851-H60	4851-H60	1	5.89	1.32	0.21

6551-H-3/6651-H-3 Thread Flange (FPT), One Piece (Solid)

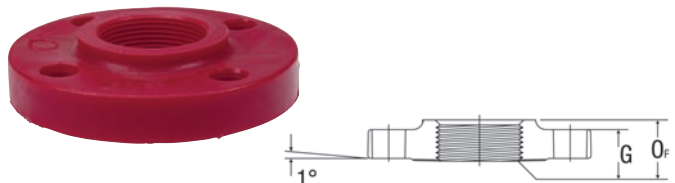

Nominal Size	Universal Part No.		Ctn. Qty.	Approx. Lbs./Ea.	Dim. G	Dim. O _F
	Red	Natural				
1/2	3852-H05	4852-H05	5	0.25	0.53	0.87
3/4	3852-H07	4852-H07	5	0.34	0.59	0.88
1	3852-H10	4852-H10	5	0.47	0.66	1.07
1 1/2	3852-H15	4852-H15	2	0.71	0.72	1.11
2	3852-H20	4852-H20	2	1.10	0.90	1.15

Chemtrol
Fig. No.

6519-H/6619-H Blind Flange, One-Piece (Solid)

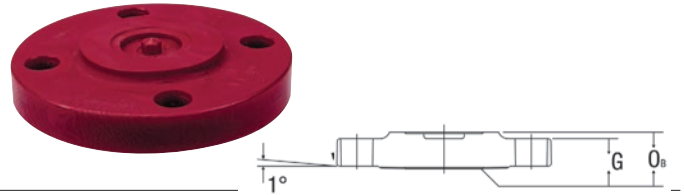

Nominal Size	Universal Part No.		Ctn. Qty.	Approx. Lbs./Ea.	Dim. G	Dim. O _B
	Red	Natural				
1/2	3853-H05	4853-H05	5	0.25	0.53	0.74
3/4	3853-H07	4853-H07	5	0.37	0.59	0.81
1	3853-H10	4853-H10	5	0.51	0.66	0.87
1 1/2	3853-H15	4853-H15	2	0.82	0.72	0.98
2	3853-H20	4853-H20	2	1.27	0.90	1.10
3	3853-H30	4853-H30	2	2.89	1.10	1.36
4	3853-H40	4853-H40	2	4.20	1.21	1.45
6	3853-H60	4853-H60	1	7.40	1.32	1.58

6551-W/6651-W Socket Flange (S), One-Piece (Webbed Design)

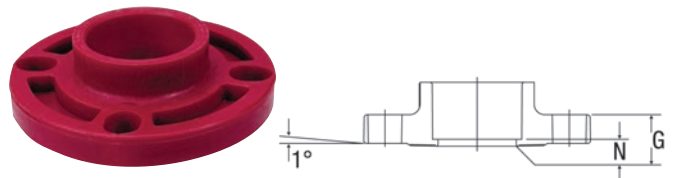

Nominal Size	Universal Part No.		Ctn. Qty.	Approx. Lbs./Ea.	Dim. G	Dim. N
	Red	Natural				
2	3851-020	4851-020	2	0.89	0.90	0.27
3	3851-030	4851-030	2	1.97	1.10	0.34
4	3851-040	4851-040	2	2.97	1.21	0.31
6	3851-060	4851-060	1	4.54	1.32	0.21

Note: One-piece webbed flanges have oblong bolt holes which permit mating with ANSI B16.5, 150lb.; BS 1560, class 150; ISO 2084, PN10; and DIN 2532, PN10.

6551-W-3/6651-W-3 Thread Flange (FPT), One-Pc (Webbed Design)

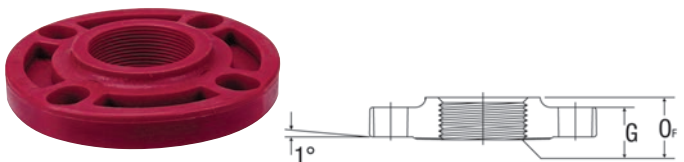

Nominal Size	Universal Part No.		Ctn. Qty.	Approx. Lbs./Ea.	Dim. G	Dim. O _F
	Red	Natural				
2	3852-020	4852-020	2	0.88	0.90	1.15

Note: One-piece webbed flanges have oblong bolt holes which permit mating with ANSI B16.5, 150 lb.; BS 1560, class 150; ISO 2084, PN10; and DIN 2532, PN10.

Kynar® is a registered trademark of Arkema Inc.

WARNING: DO NOT USE OR TEST THE PRODUCTS IN THIS CATALOG WITH COMPRESSED AIR OR OTHER GASES. FAILURE TO FOLLOW THIS WARNING CAN RESULT IN PERSONAL INJURY OR DAMAGE TO PROPERTY.

Revision 9/23/2013

Chemtrol
Fig. No.

6519-W/6619-W Blind Flange, One-Piece (Webbed Design)

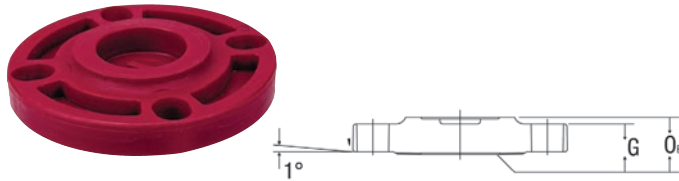

Nominal Size	Universal Part No. Red	Universal Part No. Natural	Ctn. Qty.	Approx. Lbs./Ea.	Dim. G	Dim. O _B
2	3853-020	4853-020	2	0.91	0.90	1.10
3	3853-030	4853-030	2	2.08	1.10	1.36
4	3853-040	4853-040	2	3.02	1.21	1.45
6	3853-060	4853-060	1	5.33	1.32	1.58

Note: One-piece webbed flanges have oblong bolt holes which permit mating with ANSI B16.5, 150 lb.; BS 1560, class 150; ISO 2084, PN10; and DIN 2532, PN10.

NR 51 Flange Gaskets, for Class 150 Flanges

Note: These gaskets are 1/8" thick, full face Polychloroprene (CR), 70 durometer.

Nominal Size	Part No.	Approx. Lbs./Ea.
1/2	↑ Use Figure No. & Nom. Size ↓	0.11
3/4		0.12
1		0.13
1 1/4		0.14
1 1/2		0.15
2		0.20

See page 12 for additional sizes.

Flanged Fittings*— Fabricated from Molded Components

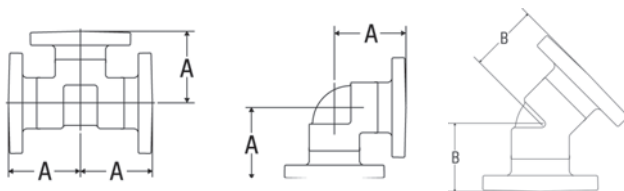

Nominal Size	Flanged Tee		Flanged 90° ELL		Flanged 45° ELL	
	Approx. Lbs./Ea.	Dim. A	Approx. Lbs./Ea.	Dim. A	Approx. Lbs./Ea.	Dim. B
1/2	0.45	2 13/32	0.41	2 13/32	0.39	2 5/32
3/4	0.68	2 23/32	0.57	2 23/32	0.53	2 15/32
1	1.04	3 3/32	0.85	3 3/32	0.86	2 23/32
1 1/2	1.73	3 31/32	1.50	3 31/32	1.43	3 13/32
2	2.80	4 15/32	2.39	4 15/32	2.12	3 27/32

*Flanged fittings are produced by heat fusion of socket flanges to socket fittings with short plain end pipe nipples.

Unions

Chemtrol
Fig. No.

6533/6633 FKM Socket Union (S x S)



Nominal Size	Universal Part No. Red	Universal Part No. Natural	Approx. Lbs./Ea.	Dim. A	Dim. L	Dim. S*
1/2	3897-005	4897-005	0.17	1.95	0.43	0.85
3/4	3897-007	4897-007	0.31	2.36	0.48	0.98
1	3897-010	4897-010	0.46	2.75	0.44	1.10
1 1/2	3897-015	4897-015	1.04	3.98	0.78	1.35
2	3897-020	4897-020	2.17	5.13	0.80	1.48

Unions are supplied with FKM O-Rings. EPDM O-Rings may be ordered for field replacement, where required. Socket x Thread is available on request.

*Socket Depth

6533-3-3/6633-3-3 FKM Socket Union (FPT x FPT)



Nominal Size	Universal Part No. Red	Universal Part No. Natural	Approx. Lbs./Ea.	Dim. A	Dim. L	Dim. T*
1/2	3898-005	4898-005	0.18	1.95	1.27	0.43
3/4	3898-007	4898-007	0.32	2.36	1.53	0.45
1	3898-010	4898-010	0.47	2.75	1.58	0.53
1 1/2	3898-015	4898-015	1.11	3.98	2.38	0.55
2	3898-020	4898-020	2.24	5.13	2.61	0.57

Unions are supplied with FKM O-Rings. EPDM O-Rings may be ordered for field replacement, where required. Socket x Thread is available on request.

* Thread Joint Engagement

Nipples

Chemtrol
Fig. No.

6529/6629 Threaded Pipe Nipple (MPT x MPT)

Example of part identification 1/2" x Short PVDF Nipple – 6129 1/2" – SH

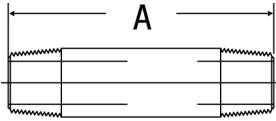

Nom. Size	Length – Close			Length – Short			Length – 3"	
	Ctn. Qty.	Approx. Lbs./Ea.	Dim. A	Ctn. Qty.	Approx. Lbs./Ea.	Dim. A	Ctn. Qty.	Approx. Lbs./Ea.
1/2	5	0.02	1.13	5	0.03	1.50	5	0.06
3/4	5	0.04	1.38	5	0.05	2.00	5	0.08
1	5	0.06	1.50	5	0.07	2.00	5	0.12
1 1/2	5	0.13	1.75	5	0.15	2.50	5	0.19
2	5	0.20	2.00	5	0.23	2.50	5	0.27

Nom. Size	Length – 4"		Length – 5"		Length – 6"	
	Ctn. Qty.	Approx. Lbs./Ea.	Ctn. Qty.	Approx. Lbs./Ea.	Ctn. Qty.	Approx. Lbs./Ea.
1/2	5	0.08	5	0.10	5	0.12
3/4	5	0.11	5	0.14	5	0.17
1	5	0.17	5	0.21	5	0.25
1 1/2	5	0.26	5	0.34	5	0.41
2	5	0.38	5	0.48	5	0.60

Chemtrol
Fig. No.

6531/6631 Plain End Pipe Nipple (SPG x SPG)

Used for fusion joining flanges to fitting or for joining any Sch. 80 fitting face-to-face.

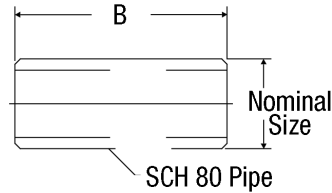

Used for joining any Sch. 80 PVDF fitting face-to-face.

Nominal Size	Universal Part No.	Ctn. Qty.	Approx. Lbs./Ea.	Dim. B
1/2		12	0.04	1.63
3/4	Use Figure No. &	12	0.06	1.86
1	Nom. Size	12	0.09	2.08
1 1/2		12	0.16	2.56
2		12	0.28	2.77
3		1	0.78	3.75

For complete technical information and more, refer to our website at www.chemtrol.com.

Actuator Mounting Data

The same plastic modular mounting kits, including fastener hardware and drive couplings, used for factory assembly, are available for field assembly of Chemtrol® actuation equipment to installed valves. When designing the CPVC mounting brackets and adapter plates we recognized that some facilities specify Chemtrol® plastic valves, but are standardized on other actuator brands. Therefore, holes in the mounting platforms are slotted and the heights of platforms over valve stems are set to offer the broadest mounting flexibility. For many reasons, including economic, the use of Chemtrol® mount kits is also encouraged when joining Chemtrol® valves to other actuator brands, and the critical data on this page is offered to facilitate adaptation.

TU Tru-Bloc® Ball Valve Min. Torque & Actuator-Mounting Dimensions

Valve Size	Min. Torque (in. lbs.)	A	B	C	D
1/2	40	3.62	2.87	1.35	0.96
3/4	50	3.62	2.87	1.87	1.53
1	50	3.62	2.87	2.16	1.70
1 1/4 / 1 1/2	90	5.25	4.50	3.01	2.46
2	170	5.25	4.50	3.75	3.07
3	360	7.00	6.00	4.75	4.00
4/6	540	8.35	7.35	5.81	5.31

Ball Valve Drive Coupling

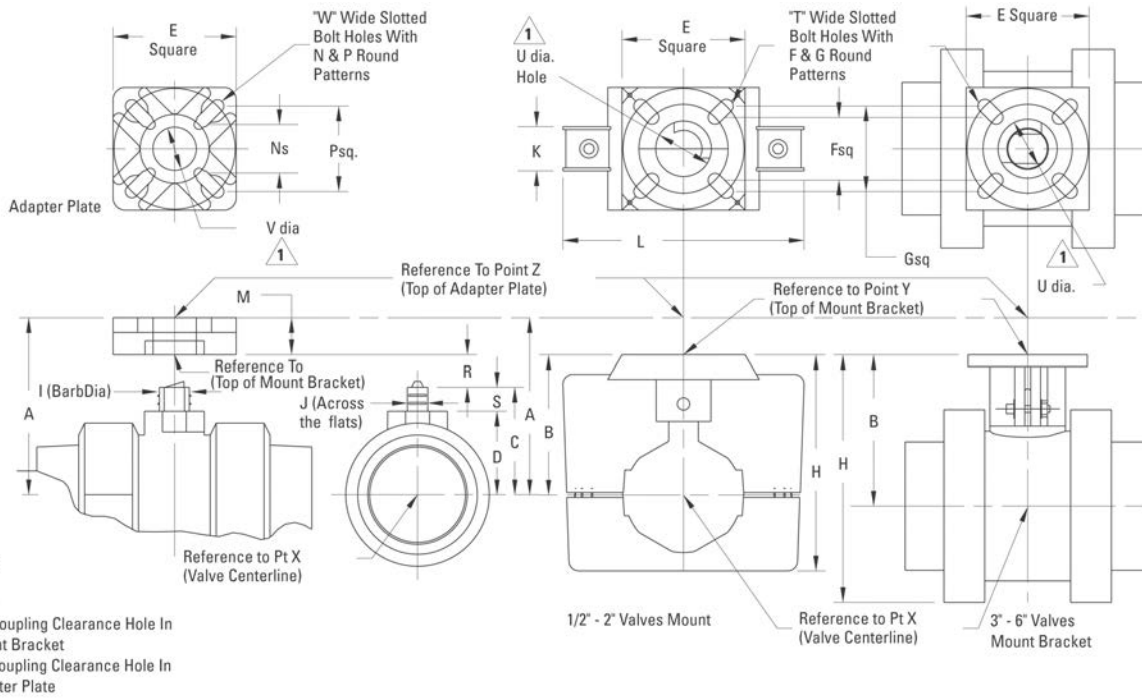
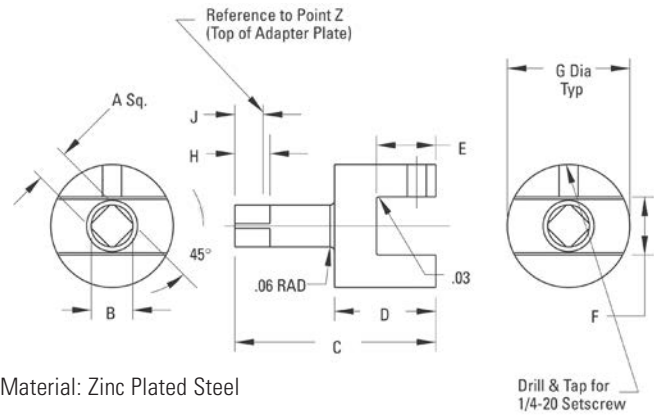

Valve Size	E		F		G		H	I	J	K	L	M	N		P		R	S	T	U	V	W
	B. C.	Sq.	B. C.	Sq.	B. C.	Sq.							B. C.	Sq.								
1/2	2.50	1.82	1.29	2.46	1.74	4.43	0.422	0.280	0.90	4.89	0.75	1.40	0.99	2.60	1.84	1.34	0.57	0.28	1.13	0.88	0.26	
3/4	2.50	1.82	1.29	2.46	1.74	4.43	0.613	0.450	0.90	4.89	0.75	1.40	0.99	2.60	1.84	1.00	0.34	0.28	1.13	0.88	0.26	
1	2.50	1.82	1.29	2.46	1.74	4.43	0.613	0.450	0.90	4.89	0.75	1.40	0.99	2.60	1.84	0.71	0.46	0.28	1.13	0.88	0.26	
1 1/4 / 1 1/2	3.00	2.46	1.74	3.02	2.14	7.22	0.738	0.535	1.26	7.32	0.75	1.40	0.99	3.02	2.14	1.49	0.55	0.34	1.64	0.88	0.32	
2	3.00	2.46	1.74	3.02	2.14	7.22	0.988	0.755	1.26	7.32	0.75	1.40	0.99	3.02	2.14	0.75	0.68	0.34	1.64	0.88	0.32	
3	5.00	2.74	1.94	5.16	3.65	9.59	1.240	0.900	-	-	1.00	1.84	1.30	5.16	3.65	1.25	0.75	0.32	1.83	1.02	0.40	
4/6	5.00	4.20	2.97	5.16	3.65	11.74	2.090	1.260	-	-	1.00	1.84	1.30	5.16	3.65	1.54	0.50	0.39	3.03	1.02	0.40	

Actuator Mounting Data

Ball Valve Mount Kit Part Numbers & Coupling Dimensions

Valve Size	Mount Kit Pt. #	Actuator Type ¹	Drive Coupling Dimensions								
			A	B	C	D	E	F	G	H	J
1/2	T111556	A/A, A/SR & E	0.351	0.437	3.08	1.81	0.67	0.281	1.10	0.46	0.42
3/4	T111557	A/A, A/SR & E	0.351	0.437	2.51	1.24	0.44	0.451	1.10	0.46	0.42
1	T111558	A/A, A/SR & E	0.351	0.437	2.34	1.07	0.56	0.451	1.10	0.46	0.42
1 1/4 / 1 1/2	T111559	A/A & E	0.351	0.437	3.24	1.97	0.65	0.539	1.61	0.46	0.45
	T111566	A/SR	0.430	0.549	3.28	1.97	0.65	0.539	1.61	0.57	0.49
2	T111560	A/A	0.430	0.549	2.64	1.33	0.78	0.761	1.61	0.50	0.46
	T111567	A/SR	0.548	0.704	2.64	1.33	0.78	0.761	1.61	0.50	0.46
	T111770	E	0.351	0.437	2.60	1.33	0.78	0.761	1.61	0.46	0.42
3	T111561	A/A & E	0.548	0.704	3.46	1.90	0.86	0.911	1.50	0.50	0.46
	T111568	A/SR	0.666	0.882	2.46	1.90	0.86	0.911	1.50	0.50	0.46 ²
4/6	T111562	A/A	0.666	0.882	3.44	1.88	0.59	1.266	1.75	0.50	0.40
	T111569	A/SR	0.863	1.000	3.44	1.88	0.59	1.266	1.75	0.50	0.40
	T111724	E	0.548	0.704	3.44	1.88	0.59	1.266	1.75	0.50	0.40

¹ A/A = Pneumatic Air to Air. A/SR = Pneumatic Air to Spring Return (fail-safe). E = Electric (motor driven).

² No adapter plate is used with this coupling. J represents distance above reference point Y (top of mount bracket).

Ball Valve Drive Coupling

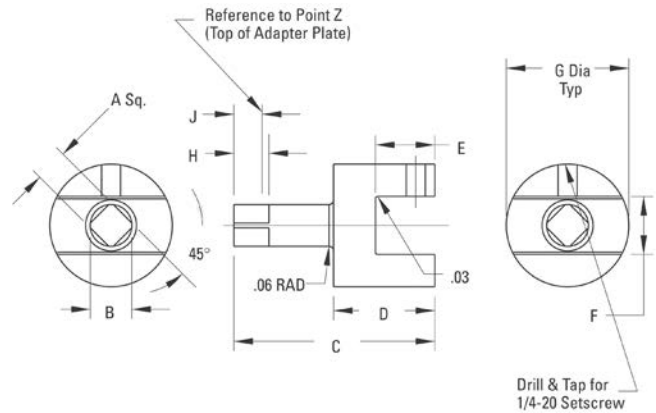

Valve Installation

For socket-end valves refer to the solvent cement joining instructions for PVC and CPVC, and the heat fusion joining instructions for PP and PVDF in the *Chemtrol Thermoplastic Piping Technical Manual*.

For threaded-end valves usually one or two turns beyond hand-tight using a suitable strap wrench, if necessary, is sufficient. Do not overtighten threads. ANSI B1.20.1 defines hand tight as 4 to 5 threads for sizes through 2" and 5 to 6-3/4 threads for sizes greater than 2".

For flanged-end valves refer to the plastic flange joining instructions in the *Chemtrol Thermoplastic Piping Technical Manual*.

CAUTION: Over tightening threads may result in damage to products.

Ball and Check Valves

When joining union-end valves, or when flanging end connectors, never make the joint to the end connectors while they are attached to the valve body. Remove the union nuts and end connectors from the valve cartridge first. Slide the union nut (smallest bore first) over the pipe or nipple and flange hub (when flanging) before making the joint to the end connector.

After allowing the proper joint drying time, or cooling time in the case of PP and PVDF, end connections may be joined to the valve cartridge. O-rings provide the seal between the valve cartridge faces and the end connectors. Ensure that these O-rings are clean and in their proper grooves before slipping the valve cartridge between its end connectors. Slide the union nuts over the end connectors and screw onto the valve cartridge threads, no more than handtight. Once the end connector engages the O-ring seal, no more than 1/8 to 1/4 turn of the union nut will fully compress the O-ring in its groove.

CAUTION: Over tightening threads may result in damage to products.

The pipe supports surrounding the valve must be loose and the adjoining piping must be well aligned with the valve. The union nuts cannot be expected to bend and/or stretch the adjoining pipe in order to allow the end connectors to make the required flush seal against the valve cartridge faces.

Check Valves - Check valves should be installed at least four feet from the discharge side of a pump. Ball chatter and internal damage may result if fluid flow is too turbulent. Also, in keeping with good mechanical design practice, the upper threshold of fluid flow recommended from Chemtrol products is five feet per second.

The valves may be installed vertically or horizontally (refer to the preceding page for minimum seating head requirements), but the molded-in flow arrow on the valve cartridge must be installed in the direction of the fluid flow such that reverse flow will be checked.

Vent Valve Conversion - The ball in a standard Chemtrol Ball Check Valve is intended by design to have a greater density than the fluid medium. When installed in the upright (seat down – arrow on body pointed in direction of normal flow) to horizontal positions, gravitational force on the ball allows it to sink in the fluid and seal at the seat in order to prevent back-flow when directional flow is ceased (e.g., pump stops). However, the mechanical designer sometimes wants air or gas to be vented from a piping system or vessel as fluid fills the system, but to check flow of fluid beyond the vent tube. As fluid is evacuated from the system or vessel, the vent valve must open to prevent formation of a vacuum. The field conversion of the check valve to the venting function requires the replacement of the standard ball with a polypropylene ball, which will float in water or fluids of greater density. A vent valve must be installed in the inverted vertical position (seat up – arrow on body pointed in opposite direction of normal venting). The floater ball must also be chemically resistant to the medium. Failure to follow these instructions may cause stress cracking to the polypropylene ball (e.g., bleach, concentrated sulfuric or nitric acids).

Valve Maintenance

Valve repair should only be performed by qualified maintenance personnel. Contact the nearest Chemtrol distributor should further information be required.

Ball Valves

Should a valve need repair, depressurize and drain the system on all sides of the valve. Loosen the valve union nuts and slide them back over the end connectors. To minimize downtime, it may be advisable to have a replacement valve cartridge ready to install in place of the one to be repaired. An advantage of the Chemtrol design is that the current model is interchangeable with all earlier models. Disassemble valve cartridge following the instructions provided with the valve.

General Design and Installation Guidelines

- The manufacturer does NOT recommend running a thermoplastic piping system with velocity greater than 5 feet/sec.
- **WARNING:** Do NOT close a quarter turn valve quickly. This will create shock in the system and cause damage to property or personal injury.
- Installing thermoplastic piping components at temperatures at 40°F requires extra precaution in handling because the material may be at increased risk of impact damage.
- **WARNING:** Follow the recommended bolt tightening techniques, including sequence of tightening and final torque values, for flanges and butterfly valves because failure to do so will result in damage to the product.
- Do not allow primer or solvent cement to come in contact with the sealing face of valve end connectors or internal components of the valve.
- Valves must be installed with the molded-in flow arrow(s) on the valve cartridge facing in the direction of the fluid flow.
- To ensure comprehensive chemical compatibility, a piping system must take into consideration the chemical resistance of all system components, including, but not limited to, plastic components, solvent cements or thread pastes (if applicable), elastomeric seals, all valve components and lubricants. Testing under field conditions may be the best way to ensure selected materials will work in a particular application.
- Consult the Chemtrol Thermoplastic Piping Technical Manual for additional design and installation requirements for Chemtrol products.

Metric Equivalent Charts

Linear Conversion Table From Fractional Inches to Millimeters

inches		mm	inches		mm
1/64	.016	.397	33/64	.516	13.097
1/32	.031	.794	17/32	.531	13.494
3/64	.047	1.191	35/64	.547	13.891
1/16	.063	1.588	9/16	.563	14.288
5/64	.078	1.984	37/64	.578	14.684
3/32	.094	2.381	19/32	.594	15.081
7/64	.109	2.778	39/64	.609	15.478
1/8	.125	3.175	5/8	.625	15.875
9/64	.141	3.572	41/64	.641	16.272
5/32	.156	3.969	21/32	.656	16.669
11/64	.172	4.366	43/64	.672	17.066
3/16	.188	4.763	11/16	.688	17.463
13/64	.203	5.159	45/64	.703	17.859
7/32	.219	5.556	23/32	.719	18.256
15/64	.234	5.953	47/64	.734	18.653
1/4	.250	6.350	3/4	.750	19.050
17/64	.266	6.747	49/64	.766	19.447
9/32	.281	7.144	25/32	.781	19.844
19/64	.297	7.541	51/64	.797	20.241
5/16	.313	7.938	13/16	.813	20.638
21/64	.328	8.334	53/64	.828	21.034
11/32	.344	8.731	27/32	.844	21.431
23/64	.359	9.128	55/64	.859	21.828
3/8	.375	9.525	7/8	.875	22.225
25/64	.391	9.922	57/64	.891	22.622
13/32	.406	10.319	29/32	.906	23.019
27/64	.422	10.716	59/64	.922	23.416
7/16	.438	11.113	15/16	.938	23.813
29/64	.453	11.509	61/64	.953	24.209
15/32	.469	11.906	31/32	.969	24.606
31/64	.484	12.303	63/64	.984	25.003
1/2	.500	12.700	1	1.000	25.400

1 inch = 25.4 millimeters

English to Metric Conversion Table

Units	Change to	Multiply by
Inches	Millimeters	25.40
Inches	Centimeters	2.54
Inches	Meters	.0254
Feet	Meters	.3048
Miles	Kilometers	1.609347
Sq. Inches	Sq. Centimeters	6.452
Sq. Feet	Sq. Meters	.0929
Cu. Inches	Cu. Centimeters	16.3872
Cu. Feet	Cu. Meters	.02832
U.S. Gallons	Liters	3.7854
Pounds	Kilograms	.45359

Metric to English Conversion Table

Units	Change to	Multiply by
Millimeters	Inches	.03937
Centimeters	Inches	.39371
Meters	Inches	39.371
Meters	Feet	3.281
Kilometers	Miles	.62137
Sq. Centimeters	Sq. Inches	.1550
Sq. Meters	Sq. Feet	10.7649
Cu. Centimeters	Cu. Inches	.061
Cu. Meters	Cu. Feet	35.314
Liters	U.S. Gallons	.26417
Kilograms	Pounds	2.20462

Physical Properties of Thermoplastic Piping Materials

ASTM Test Methods	Properties	Material			
		PVC 12454-B	CPVC 23447-B	PVDF	Polypropylene
General					
D792	Specific Gravity	1.38	1.50	1.76	.905
D570	Water Absorption % 24 Hrs. @ 73°F	.05	.05	.04	.02
Mechanical					
D638	Tensile Strength psi @ 73°F	7,300	7,200	6,000	4,600
D638	Modulus of Elasticity in Tension psi @ 73°F x 10 ⁵	4.2	3.7	2.1	2.0
D790	Flexural Strength psi	14,500	15,600	9,700	7,000
D256	Izod Impact Strength @ 73°F (Notched)	1.1	2.0	3.8	.8
Thermal					
D696	Coefficient of Thermal Expansion in/in/°F x 10 ⁻⁵	3.0	3.8	7.9	5.0
C177	Thermal Conductivity BTU/HR/Sq. Ft./°F/in	1.2	.95	.79	1.2
D648	Heat Distortion Temp. °F @ 66 psi	NA	NA	284	195
D648	Heat Distortion Temp. °F @ 264 psi	163	212	194	140
	Resistance to Heat °F at Continuous Drainage	140	210	280	180
Flammability					
D2863	Limiting Oxygen Index (%)	43	60	44	17
E84	Flame Spread	< 25	< 25	< 25	NA
E84	Smoke Generation Underwriters Lab Rating (Sub. 94)	> 250 94V-0	< 250 94V-0	< 50 94V-0	> 450 94HB

Dimensions and References

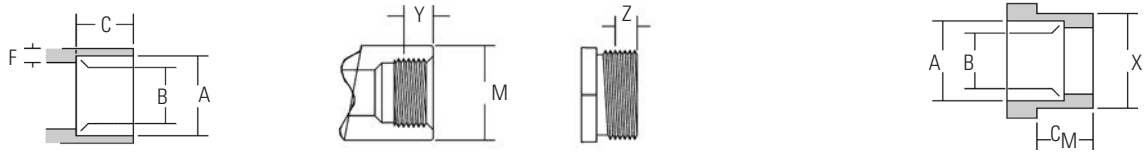

Fittings¹

Size	IPS Dia	Solvent Socket (S)			Female Threads (FPT)		Male Threads (MPT)	Male End (SPG)		Wall Thickness	
		A ³	B ³	C ⁴ Nom	Y ²	M ⁵ Min	Z ²	X	Cm ⁴ Nom	F ⁴ Min	E ⁴ Min
1/4	.540	.552	.536	.640	.311	.840	.311	.540	.655	.149	.119
1/2	.840	.848	.836	.890	.427	1.280	.427	.840	.905	.185	.147
3/4	1.050	1.058	1.046	1.015	.446	1.500	.446	1.050	1.030	.195	.154
1	1.315	1.325	1.310	1.140	.530	1.810	.530	1.315	1.155	.225	.179
1 1/4	1.660	1.670	1.655	1.265	.550	2.200	.550	1.660	1.280	.240	.191
1 1/2	1.900	1.912	1.894	1.390	.550	2.500	.550	1.900	1.405	.250	.200
2	2.375	2.387	2.369	1.515	.566	2.375	.566	2.375	1.530	.275	.218
2 1/2	2.875	2.889	2.868	1.780	.870	3.560	.870	2.875	1.810	.345	.276
3	3.500	3.516	3.492	1.905	.954	4.300	.954	3.500	1.933	.375	.300
4	4.500	4.518	4.491	2.280	1.032	5.430	1.032	4.500	2.310	.420	.337
6	6.625	6.647	6.614	3.030	–	–	–	6.625	3.060	.540	.432
8	8.625	8.655	8.610	4.500	–	–	–	8.625	4.590	.625	.500
10	10.750	10.780	10.735	5.500	–	–	–	10.750	5.590	.741	.593
12	12.750	12.780	12.735	6.500	–	–	–	12.750	6.590	.859	.687

¹ With exception of thread lengths, dimensions shown are listed in ASTM D2467 and F439 for PVC and CPVC socket-type Schedule 80 fittings, respectively.

² Dimensions shown are typical male component engagement, hand-tight (L_t in ANSI B1.20.1 thread spec.) plus 1 1/2 turns lightening.

³ Dimensions shown are not applicable for polypropylene or PVDF. Socket diameters in these materials are designed for Chemtrol thermo-seal socket fusion joining.

⁴ Chemtrol® fittings may exceed certain minimum ASTM dimensional requirements in order to ensure functional satisfaction.

⁵ Dimensions are listed in ASTM D2464 and F437 for PVC and CPVC threaded Schedule 80 fittings, respectively.

Dimensions and References

National (American) Standard Taper Pipe Thread, NPT (excerpt from ANSI B1.20.1)

Nominal Size	Outside Diameter D	Number of Threads Per Inch n	Pitch of Thread p	Normal Engagement By Hand L ₁	Length of Effective Thread L ₂	Wrench Makeup Length for Internal Thread L ₃	Total Length: End of Pipe to Vanish Point L ₄	Pitch Diameter at Beginning of External Thread E ₀	Pitch Diameter at Beginning of Internal Thread E ₁	Height of Thread (Max.) h
in.	in.		in.	in.	in.	in.	in.	in.	in.	in.
1/4	0.540	18	.05556	.228	.4018	.1667	.5946	.47739	.49163	.04444
1/2	0.840	14	.07143	.320	.5337	.2143	.7815	.75843	.77843	.05714
3/4	1.050	14	.07143	.339	.5457	.2143	.7935	.96768	.98887	.05714
1	1.315	11 1/2	.08696	.400	.6828	.2609	.9845	1.21363	1.23863	.06957
1 1/4	1.660	11 1/2	.08696	.420	.7068	.2609	1.0085	1.55713	1.58338	.06957
1 1/2	1.900	11 1/2	.08696	.420	.7235	.2609	1.0252	1.79609	1.82234	.06957
2	2.375	11 1/2	.08696	.436	.7565	.2609	1.0582	2.26902	2.29627	.06957
2 1/2	2.875	8	.12500	.682	1.1375	.2500	1.5712	2.71953	2.76216	.10000
3	3.500	8	.12500	.766	1.2000	.2500	1.6337	3.34062	3.38850	.10000
4	4.500	8	.12500	.844	1.3000	.2500	1.7337	4.33438	4.38712	.10000

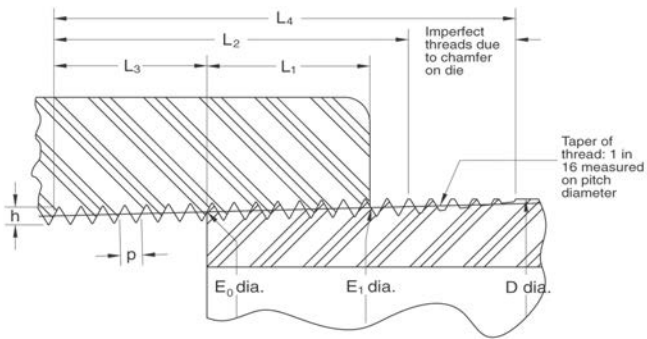

Do not thread Schedule 40 pipe.

Pressure Factors

Pressure measurements are based on the standardized weight of water expressed in a variety of English and metric units.

1 psig (gauge)	=	2.3068	foot of water head
	=	2.036	inch of mercury head
	=	0.0689	bar
	=	0.0703	kgm/cm ² (kilograms/centimeter ²)
	=	6894.757	N/m ² (newton/meter ²)
	=	6.8948	kPa (kilopascal)
1 foot of water	=	0.4335	psig
	=	0.0305	kgm/cm ² (kilograms/centimeter ²)
	=	2988.8837	N/m ² (newton/meter ²)
	=	0.33457	kPa (kilopascal)
	=	0.02989	bar
1 bar	=	100000.0	N/m ² (newton/meter ²)
	=	14.50377	psig
	=	100.0	kPa (kilopascal)
	=	10197.1621	kgm/cm ² (kilograms/centimeter ²)
	=	33.456	foot of water head
1 N/m ² (newton/meter ²)	=	1.0	Pa (pascal) = 0.001 kPa (kilopascal)
	=	0.000010197	kgm/cm ²
	=	0.000145	psig (gauge)
1 kilogram/centimeter ²	=	98066.5	N/m ² (newton/meter ²)
	=	14.2233	psig

ANSI B16.5 Dimensional Data – Flanges and Flanged Fittings

Nominal Pipe Size (In.)	Outside Diameter (In.)	Number of Holes	Drilling	
			Diameter of Bolt (In.)	Diameter of Bolt Circle (In.)
1/2	3.50	4	1/2	2.38
3/4	3.88	4	1/2	2.75
1	4.25	4	1/2	3.12
1 1/4	4.62	4	1/2	3.50
1 1/2	5.00	4	1/2	3.88
2	6.00	4	5/8	4.75
2 1/2	7.00	4	5/8	5.50
3	7.50	4	5/8	6.00
4	9.00	8	5/8	7.50
6	11.00	8	3/4	9.50
8	13.50	8	3/4	11.75
10	16.00	12	7/8	14.25
12	19.00	12	7/8	17.00

† Dimensions and bolts conform to ANSI B16.5 for 150 lb. steel flanges. Bolt holes are 1/8" larger in diameter than the required bolts.

Vacuum Factors

Vacuum may be thought of as the absence of pressure. It is the measure of negative pressure between standardized atmospheric pressure and a theoretically perfect vacuum.

1 Std. Atmosphere	=	14.6959	psia (absolute)
	=	760.0	mm (millimeter) of mercury head
	=	1.0332276	kgm/cm ² (kilograms/centimeter ²)
	=	1.01325	bar
	=	101.325	kPa (kilopascal)
1 mm	=	0.03937	inch
1 micron of mercury	=	0.001	mm (millimeter) of mercury head
	=	0.000019336	psig (gauge)
1 mm of mercury	=	1000.0	micron of mercury head
1 inch	=	25.4	mm (millimeter)
1 inch of mercury	=	25400.0	micron of mercury head
	=	0.4912	psig
1 inch of water	=	0.0361	psig
	=	1868.2742	micron of mercury head
1 psig (gauge)	=	27.6817	inch of water head

Pressure Ratings of Chemtrol Products

Fittings

In order to determine the pressure rating for product system, first find the plastic material and schedule (wall thickness—see Reference Data—Schedule 80 components for additional information) of fittings in the heading of the Maximum Nonshock Operating Pressure table below. Then, locate the selected joining method in the subheading of the table and go down the column to the value across from a particular pipe size, listed in the far left column. This will be the maximum non-shock operating pressure at 73° F for the defined product system.

Maximum Nonshock Operating Pressure (psi) at 73° F¹

Nom. Pipe Size	Schedule 40		Schedule 80		Schedule 80 Polypropylene		Schedule 80 PVDF (Kynar®)	
	CPVC	PVC & CPVC	Socket End	Socket End	Thermo-Seal Joint	Thermo-Seal Joint	Threaded ³ End	Threaded ³ End
1/2	600	850	420	410	20	580	290	
3/4	480	690	340	330	20	470	230	
1	450	630	320	310	20	430	210	
1 1/4	370	520	260	260	20	-----	-----	
1 1/2	330	470	240	230	20	326	160	
2	280	400	200	200	20	270	140	
2 1/2	300	420	210	-----	-----	-----	-----	
3	260	370	190	190	20	250	N.R.	
4	220	320	160	160	20	220	N.R.	
6	180	280	N.R.	140	N.R.	190	N.R.	
8	160	250 ²	N.R.	-----	-----	-----	-----	
10	140	230	N.R.	-----	-----	-----	-----	
12	130	230	N.R.	-----	-----	-----	-----	

- For more severe service, an additional correction factor may be required.
 - 8° CPVC Tee, 90° ELL and 45° ELL rated at 1/2 of value shown.
 - Recommended for intermittent drainage pressure not exceeding 20 psi. Not available in natural polypropylene.
- N.R. Not Recommended and NOT WARRANTED by manufacturer.

As implied by the preceding, the pressure for all thermoplastic piping is a function of temperature. For fitting applications above 73° F, refer to the table at the top of the next column for the Temperature Correction Factors. To determine the maximum non-shock pressure rating at an elevated temperature, simply multiply the base pressure rating obtained from the upper table by the correction factor from the upper table in the next column. Below 73° F the pressure rating will be the same as the base pressure in the table above.

Temperature Correction Factors

Operating Temperature (° F)	Factors PVC	CPVC	PP	Kynar® PVDF
70	1.00	1.00	1.00	1.00
80	0.90	0.96	0.97	0.95
90	0.75	0.92	0.91	0.87
100	0.62	0.85	0.85	0.80
110	0.50	0.77	0.80	0.75
115	0.45	0.74	0.77	0.71
120	0.40	0.70	0.75	0.68
125	0.35	0.66	0.71	0.66
130	0.30	0.62	0.68	0.62
140	0.22	0.55	0.65	0.58
150	N.R.	0.47	0.57	0.52
160	N.R.	0.40	0.50	0.49
170	N.R.	0.32	0.26	0.45
180	N.R.	0.25	*	0.42
200	N.R.	0.18	N.R.	0.36
210	N.R.	0.15	N.R.	0.33
240	N.R.	N.R.	N.R.	0.25
280	N.R.	N.R.	N.R.	0.18

* Recommended for intermittent drainage pressure not exceeding 20 psi. N.R. Not Recommended and NOT WARRANTED by manufacturer.

Temperature Conversion

$$F = C \times 1.8 + 32 \quad C = (F - 32) \div 1.8$$

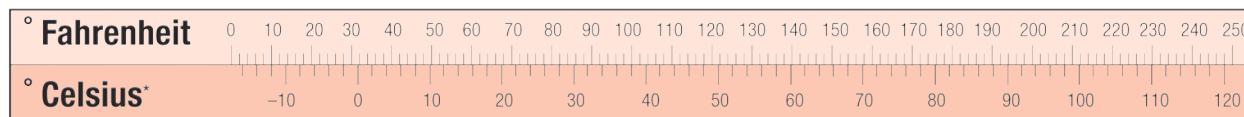

* Formerly known as Centigrade

Pressure Ratings of Chemtrol Products

Valves, Unions, and Flanges

As with all other thermoplastic piping components, the maximum pressure rating for all Chemtrol® valves, unions and flanges, regardless of size, is related to temperature as per the chart below.

Maximum Non-Shock Operating Pressure (psi) vs. Temperature

Operating Temperature (° F)	Model D Ball Valve		All Other Valves, Unions & Flanges			
	PVC	CPVC	PVC	CPVC	PP	PVDF
70	250	250	150	150	150	150
80	250	250	150	150	150	150
90	225	250	150	150	150	150
100	200	240	150	150	150	150
110	180	220	135	140	140	150
120	165	190	125	130	130	150
130	140	180	110	120	118	150
140	130	170	50	110	105	150
150	N.R.	160	N.R.	100	93	140
160	N.R.	150	N.R.	90	80	133
170	N.R.	140	N.R.	80	70	125
180	N.R.	130	N.R.	70	50	115
200	N.R.	65	N.R.	50	N.R.	97
210	N.R.	30	N.R.	25	N.R.	85
220	N.R.	N.R.	N.R.	N.R.	N.R.	75
240	N.R.	N.R.	N.R.	N.R.	N.R.	55
260	N.R.	N.R.	N.R.	N.R.	N.R.	40
280	N.R.	N.R.	N.R.	N.R.	N.R.	25

N.R. Not Recommended and NOT WARRANTED by manufacturer.

Chemtrol® Valve Construction and Performance Standards

For over 55 years, the construction and performance standards on plastic valves have traditionally been set by Chemtrol products for the industry to follow. Specifying engineers should know that:

1. Chemtrol valves are 100% seat and shell tested.
2. The sockets of PVC and CPVC Chemtrol valves conform to the dimensional requirements of ASTM Standards D2467 (PVC) and F439 (CPVC) for Schedule 80 Socket pressure fittings. For dimensional details please reference the data on the preceding pages.
3. The threaded end connections of all Chemtrol valves meet ANSI B1.20.1 (was ASA B2.1) requirements for National (American) Standard Pipe Taper Threads and conform to the dimensional requirements of ASTM Standards D2464 (PVC) and F437 (CPVC) for Schedule 80 Threaded pressure fittings.
4. The flanges attached to all Chemtrol valves meet the outside diameter and bolt hole requirements of ANSI B16.5 for 150 lb. Steel Pipe Flanges.
5. The physical and chemical properties of PVC and CPVC are classified and grouped into characteristic materials by ASTM Standard D1784. The materials, used in domestically produced Chemtrol Valves, exceed the rigid requirements set forth for cell class 12454 (PVC) and 23447 (CPVC). These are the respective materials stipulated for use in pipes which merit the highest Hydrostatic Design Stress rating (2000 psi) and the maximum corrosion resistance.
6. Independent third party tested and certified PVC and CPVC Chemtrol Valves are regularly tested for compliance with NSF/ANSI 14 "Plastic Piping System Components and Related Materials" requirements establishing minimum physical, performance, and health effect requirements for the protection of public health and the environment.

Valve Pressure-Loss Calculations

As an aid to system design, fluid flow coefficients (C_v values) are shown for all Chemtrol valves. C_v is defined as the flow, in GPM, through a valve which will produce a pressure drop of 1.0 PSI when the medium is water at 60°F.

To determine the pressure drop for a given condition, the following formula may be used:

$$\Delta P = \frac{Q^2 S.G.}{C_v^2}$$

Where ΔP = Pressure drop across the valve in psi
 Q = Flow through the valve in gpm
 $S.G.$ = Specific gravity of the liquid (water = 1.0)
 C_v = Fluid flow coefficient

The solution of an example problem follows. Refer to the product description page in this Valve Guide for C_v values of specific valves.

Example

Find the pressure drop across a 1 1/2" Ball Check Valve with a water flow rate of 50 gpm.

The C_v for the Chemtrol® Check Valve is 56, as shown on page 11.

$$\Delta P = \frac{(50)^2 \times 1.0}{(56)^2}$$

$$\Delta P = \left(\frac{50^2}{56^2} \right)$$

$$\Delta P = .797 \text{ psi}$$

Many commercial, industrial, and governmental standards or specifications are available to assist the design engineer in specifying plastic piping systems. Standards most frequently referred to and most commonly called out in plastic piping specifications are ASTM Standards. These standards also often form the basis of other standards in existence. Below is a list and description of those standards most typically applied to industrial plastic piping.

ASTM D1784**(American Society for Testing and Materials)**

This specification covers rigid PVC and CPVC compounds intended for general purpose use in extruded or molded form including pressure piping applications and nonpressure piping applications composed of poly(vinyl chloride), chlorinated poly(vinyl chloride), or vinyl chloride copolymers containing at least 80% vinyl chloride, and the necessary compounding ingredients.

ASTM D1785 and F441

These standards cover the specification and quality of Schedule 40, 80, and 120 PVC (D1785) and CPVC (F441) pressure pipe. Outlined in these standards are dimensional specifications, burst, sustained, and maximum operating pressure requirements and test procedures for determining pipe quality with respect to workmanship and materials.

ASTM D2466

This standard covers Schedule 40 PVC threaded and socket pressure fittings. Stipulated in the standard are thread and socket specifications, by lengths, wall thickness, burst, material, quality, and identification requirements.

ASTM D2467 and F439

These standards cover Schedule 80 PVC (D2467) and CPVC (F439) Socket Type and Threaded Pressure Fittings. Dimensions, burst strength, resin compound stipulation, and scheme of product identification requirements are specified.

ASTM D2564 and F493

These standards set forth requirements for PVC (D2564) and CPVC (F493) Solvent Cement. The specification identifies the resin compound to be used and stipulates minimum resin content, solution viscosities, and physical performance qualities.

ASTM F656

This specification covers requirements for primers for use with poly(vinyl chloride) (PVC) pipe and fittings that are to be joined by PVC solvent cements meeting the requirements of Specification.

ASTM F1970

This specification covers special engineered fittings or appurtenances for use in PVC or CPVC systems. Flanges, unions, and valves not included in the scope of other ASTM specifications are specifically referenced. Minimum requirements are identified for testing, materials, dimensions, marking, and in-plant quality control.

ASTM F1498

This specification adapts the General Purpose American Pipe Thread Specification, ASME B1.20.1, to taper pipe threads for use on plastic pipe and fittings with machined or molded threads. The standard covers dimensions and gaging of plastic tapered National Pipe Threads (NPT) for leak-tight joints, and it is now referenced in all ASTM Standards for plastic piping products.

ASTM D2855

This standard describes the procedure for making joints with PVC pipe and fittings by means of solvent cementing.

ASTM D4101 (Formerly D2146)

This specification covers polypropylene materials suitable for injection molding and extrusion. Polymers consist of homopolymer, copolymers, and elastomer compounded with or without the addition of impact modifiers (ethylene-propylene rubber, polyisobutylene rubber, and butyl rubber), colorants, stabilizers, lubricants, or reinforcements.

ASTM D1599

This standard covers the test method for establishing the short-term hydraulic failure pressure of thermoplastic pipe, tubing, and fitting under specific temperature, time, and method of loading conditions. These test techniques are normally used for quality control.

ASTM D1598

This test method covers the determination of the time-to-failure of both thermoplastic and reinforced thermosetting/resin pipe under constant internal pressure.

ASTM D2837

This standard describes the procedure for obtaining the Hydrostatic Design Basis for all known thermoplastic pipe materials and for any practical temperature and medium. This was achieved by evaluating stress rupture data, taken from tests conforming to ASTM D1598, for the subject material and involved specified treatment and analysis of data.

ASTM D2657

This standard covers the procedure for heat-fusion bonding of polyolefin materials.

ASTM D3222

This standard covers the polymerization method and physical properties of PVDF (polyvinylidene fluoride) Fluoroplastic Materials for molding and extrusion.

Organizations other than ASTM issue standards that are commonly encountered in industrial thermoplastic piping design. The most important of these are described below.

ASME B1.20.1 (was B2.1)

This specification details the dimensions and tolerance for tapered pipe threads. This standard is referenced in the ASTM standards for threaded fittings mentioned above. See Reference Data for details.

ASME B16.5

This specification sets forth standards for bolt holes, bolt circles, and overall dimensions for steel 150# flanges. See Reference Data for details.

Technical Service

Technical assistance regarding standards, applications, product performance, design, and installation tips is available from Technical Services Technical Information Hotline: (888) 446-4226 phone; (888) 336-4226 fax.

Polypropylene (PP) Schedule 80 Industrial Fittings

Scope:

This specification establishes the manufacturing requirements for black and Chem-Pure® Schedule 80 polypropylene piping components intended for use in industrial, pressure-rated, fluid-handling systems for applications at 180° F or less, where resistance to corrosion are of prime importance.

Materials:

Rigid PP (polypropylene) used in the manufacture of Schedule 80 piping components shall be one of the following:

Black Polypropylene:

- Pipe-material shall be Cell Class PP0110-A2-1510 as per ASTM D4101. Fittings material shall be Cell Class PP0110-M30-A10120 (glass bead material) and Cell Class PP0110-B67154 (unfilled material) as per ASTM D4101. These materials shall be pigmented jet black.

Chem-Pure (Natural) Polypropylene:

- Pipe material shall be Cell Class PP0110-A2-1510 as per ASTM D4101. Fitting material shall be Cell Class PP0210-B45145 as per ASTM D4101. These materials shall be unpigmented.

Dimensions/Design (IPS Size):

Socket-end connections suitable for heat-fusion welding shall have socket lengths and wall thicknesses as required for Schedule 80 fittings in ASTM D2467. Socket diameters shall be in accordance with the manufacturer's recommendations for an interference fit with the pipe as prescribed in ASTM D2657; taper pipe threaded-ends shall have lengths, diameters, and configuration in accordance with ASTM D2467 for Schedule 80 fittings.

Pipe shall have diameters and wall thicknesses in conformance with ASTM D1785 for Schedule 80 pipe.

Fittings shall be industrial, heavy-duty, hub style.

Flanges shall be one-piece design utilizing the tapered-, serrated-, and full-face gasket technique for joining, with bolt pattern compatible with ASME B16.5 Class 150 metal flanges.

Unions shall have an O-ring seal and components interchangeable with true union valves for maximum system versatility.

Transition unions, unions intended for joining dissimilar materials, shall utilize components of the two dissimilar materials, joined with an elastomeric seal to absorb the thermal-expansion coefficient differential.

Pressure Ratings:

Pipe and fittings joined by the heat-fusion technique shall be rated according to the following pressures for a given nominal size at 73° F water service.

1/2 – 410 psi	1 – 310 psi	2 – 200 psi	4 – 160 psi
3/4 – 330 psi	1-1/2 – 230 psi	3 – 190 psi	6 – 140 psi

NOTE: Threaded pipe and fittings shall be rated at 20 psi maximum for all sizes at 73° water service.

Heat-fusion valves, unions, and flanges shall be rated at 150 psi for non-shock water service at 73° F and have a minimum 60 second burst requirement of 3.2 times the rated pressure.

Markings:

Fittings and pipe shall be clearly marked with the manufacturer's name or trademark, nominal size, material designation, and country of manufacture.

Installation/Maintenance:

Installation and operation shall be as specified by the manufacturer's printed instructions. Specialized joining equipment shall be as recommended by the manufacturer.

Polyvinylidene Fluoride (PVDF) (KYNAR®) Schedule 80 Industrial Fittings

Scope:

This specification establishes the manufacturing requirements for red and natural PVDF Schedule 80 piping components intended for use in industrial, pressure-rated, fluid-handling systems of 280° F or less where resistance to corrosion are of prime importance.

Materials:

Rigid PVDF (polyvinylidene fluoride) used in the manufacture of Schedule 80 piping components shall conform to requirements in ASTM D3222 for Type I homopolymers. Pipe and fitting components shall be manufactured from one of the following:

Red Kynar®:

PVDF compound with a minimum of 1.7% red pigment content for opacity to UV radiation.

Natural Kynar®:

Unpigmented 700 series PVDF compound of the highest purity.

Dimensions/Design:

Socket-end connections suitable for heat-fusion welding shall have socket lengths and wall thicknesses conforming to ASTM D2467 and socket diameters shall be in accordance with the manufacturer's printed recommendations to provide an interference-fit with the pipe; taper pipe threaded-ends shall have thread lengths, diameters, and configurations in conformance with ASTM D2467.

Pipe shall be manufactured to the same tolerances for outside diameter and wall thicknesses as outlined in ASTM D1785 for Schedule 80 pipe.

Fittings shall be industrial, heavy-duty, hub style.

Unions shall have an O-ring seal and components interchangeable with true union valves for maximum system versatility.

Transition unions, unions intended for joining dissimilar materials, shall utilize components of the two dissimilar materials, joined with an elastomeric seal to absorb the thermal-expansion coefficient differential.

Pressure Ratings:

Pipe and fittings joined by the heat-fusion technique shall be rated according to the following pressures for a given nominal size at 73° F water service.

1/2 – 580 psi	1 – 430 psi	2 – 270 psi	4 – 220 psi
3/4 – 470 psi	1-1/2 – 320 psi	3 – 260 psi	6 – 190 psi

NOTE: Threaded pipe and fittings shall be rated at 50% of the values given for socket ends.

Valves, unions, and flanges (either socket or threaded end) shall be pressure rated at 150 psi non-shock water service at 73° F and have a minimum 60 second burst requirement of 3.2 times the rated pressure.

Markings:

All pipe, fittings, and valves shall be clearly marked with the manufacturer's name or trademark, nominal size, and country of manufacture.

Installation:

Installation and operation shall be as specified by the manufacturer's printed instructions. Specialized joining equipment shall be as recommended by manufacturer.

150 PSI Tru-Bloc® True Union Ball Valves, Model C

Scope:

This specification establishes the manufacturing requirements for dual-blocking (Tru-Bloc) and downstream-only blocking (true union) quarter-turn ball valves of PP and PVDF materials intended for use in industrial, commercial, and residential pressure-piping systems, where cost-effective, long-term resistance to corrosion is of prime importance, and the service temperature does not exceed: PP, 180° F; PVDF, 280° F.

Major component parts shall be constructed from one of the following:

NPS 1/2 – 4 PP (polypropylene) Cell Class PP0110-M30-A10120 (glass-filled material) and Cell Class PP0110-B67157 (unfilled material) as per ASTM D4101. These materials shall be pigmented jet black. Valve style shall be full-port True Union.

NPS 1/2 – 4 Chem-Pure® (natural polypropylene) Cell Class PP0210-B45145 as per ASTM D4101. Materials shall be unpigmented and of the highest purity. Valve style shall be full-port True Union.

NPS 1/2 – 4 PVDF (polyvinylidene fluoride) Type I compound per ASTM D3222. The material shall be red Kynar® (pigmented red) for maximum UV opacity, and the valve style shall be full-port Tru-Bloc, TU or True Union.

NPS 1/2 – 4 PVDF (polyvinylidene fluoride) Type I compound per ASTM D3222. The material shall be natural (unpigmented) 700 Series Kynar® of the highest purity and the valve style shall be full-port Tru-Bloc, TU or True Union.

Dimensions/Valve Design:

PP and PVDF socket-end connections shall be suitable for heat-fusion welding as specified in ASTM D2567 Technique I.

All threaded-end connections shall conform to the requirements of ASTM D2467 and F439 as well as ASTM F1498 for tapered pipe threads.

Performance:

Valves shall be rated for 150 psi non-shock water service at 73° F water and have a minimum burst rating of 3.2 times the rated working pressure.

Markings:

Valves shall be clearly marked with the manufacturer's name or trademark, nominal size, material designation, ASTM number or equivalent symbol indicating compliance with applicable standards, and country of manufacture.

Installation:

Installation and operation shall be as specified by the manufacturer's printed instructions.

150 PSI Ball Check and Foot Valves

Scope:

This specification establishes the manufacturing requirements for PP and PVDF ball check valves intended for use in industrial, commercial, and residential pressure-piping systems, where cost-effective, long-term resistance to corrosion is of prime importance. Maximum service temperatures are: PP, 180° F; PVDF, 280° F.

Materials:

Major component parts shall be constructed from one of the following:

NPS 1/2 – 2 PP (polypropylene) Cell Class PP0110-M30-A10120 (glass-filled material) and Cell Class PP0110-B67157 (unfilled material) as per ASTM D4101. These materials shall be pigmented jet black.

NPS 1-1/2 – 2 Chem-Pure® (natural polypropylene) Cell Class PP0210-B45145 as per ASTM D4101. Materials shall be unpigmented and of the highest purity.

NPS 1/2 – 2 PVDF (polyvinylidene fluoride) Type I compound per ASTM D3222. The material shall be pigmented red for maximum UV opacity.

NPS 1/2 – 2 PVDF (polyvinylidene fluoride) Type I compound per ASTM D3222. The material shall be natural (unpigmented) 700 Series Kynar® of the highest purity.

Dimensions/Valve Design:

PP and PVDF socket-end connections shall be suitable for heat-fusion welding as specified in ASTM D2567 Technique I. All threaded-end connections shall conform to the requirements of ASTM D2467 and F439 as well as ASTM F1498 for tapered pipe threads.

The valve design shall be full port with full flow around the rib-guided ball.

The valve seat shall be an elastomeric seal that will permit seating at low-head pressure, and an arrow shall be molded on the valve body for permanent visibility to indicate the intended direction of flow.

Markings:

Valves shall be clearly marked with the manufacturer's name or trademark, nominal size, material designation, ASTM number or equivalent symbol indicating compliance with applicable standards, and county of manufacture.

Performance:

Valves shall be rated for 150 psi service at 73° F non-shock water service and have a minimum burst rating of 3.2 times the rated working pressure.

Installation:

Installation and operation shall be as specified by the manufacturer's printed instructions.

NIBCO® Chemtrol® Valves & Industrial Plastic Fittings & Flanges Limited Warranty

NIBCO INC. LIMITED WARRANTY

Applicable to NIBCO Chemtrol Valves and Industrial Plastic Fittings and Flanges

NIBCO INC. warrants each Chemtrol valve and industrial plastic fitting and flange to be free from defects in materials and workmanship under normal use, service, and maintenance in accordance with the product specifications (including, but not limited to installation recommendations) for a period of one (1) year from the Warranty Commencement Date. The Warranty Commencement Date shall be the date of purchase.

NIBCO Chemtrol valves and industrial plastic fittings and flanges are referred to herein as “NIBCO Products.”

NIBCO will repair or replace – at its option and at no charge – NIBCO Products that have been determined by NIBCO, or an authorized representative or agent thereof, to have failed solely because of a defect in materials or workmanship under normal use, service, and maintenance during the warranty period. Replacements shall be shipped free of charge to the owner.

This limited warranty applies to all NIBCO Products installed, tested, applied, and used in accordance with NIBCO’s approved and published recommendations and instructions.

This warranty does not cover any failure or damage for or caused by:

1. any product, parts, or systems which are not manufactured or sold by NIBCO;
2. any NIBCO Product which is used for purposes other than a purpose authorized by NIBCO;
3. any NIBCO Product not installed, tested, applied, used, or maintained in accordance with NIBCO’s recommended installation guidelines and instructions;
4. any NIBCO Product not installed or used in accordance with applicable codes;
5. any damage caused by, contributed in whole or in part by, or resulting from, any of the following:
 - a. abuse, misuse, mishandling, alteration, tampering, neglect, or accidental damage such as, without limitation, vandalism;
 - b. natural disasters, such as, without limitation, flooding, windstorm, and lightning;
 - c. attachments or modifications not authorized by NIBCO;
 - d. external, physical or chemical qualities, or an unsuitable or hostile environment,;
 - e. any defects other than those in material or workmanship; or
 - f. any other cause beyond the control of NIBCO.

NIBCO DISCLAIMS ANY AND ALL LIABILITY FOR ANY OTHER DIRECT OR INDIRECT, INCIDENTAL, OR CONSEQUENTIAL DAMAGES OF ANY KIND, INCLUDING BUT NOT LIMITED TO, ECONOMIC LOSS, LOSS OF BUSINESS, LOST PROFITS, PUNITIVE DAMAGES, MOLD INTRUSION, WATER DAMAGE, ETC.

Some states do not allow the exclusion or limitation of damages, so the above limitation or exclusion may not apply to you.

THIS WARRANTY IS THE ONLY WARRANTY FOR THE NIBCO PRODUCTS PROVIDED BY NIBCO, AND IS AND SHALL BE IN LIEU OF ANY AND ALL OTHER WARRANTIES, EXPRESSED OR IMPLIED, INCLUDING, BUT NOT LIMITED TO, AN IMPLIED WARRANTY OF MERCHANTABILITY OR FITNESS FOR A PARTICULAR PURPOSE, AND FOR ALL OTHER OBLIGATIONS OR LIABILITIES ON THE PART OF A MANUFACTURER. NO EMPLOYEE OF NIBCO, OR ANY OTHER DISTRIBUTOR, AGENT, OR OTHER PERSON OR BUSINESS, IS AUTHORIZED TO MAKE ANY OTHER WARRANTY ON BEHALF OF NIBCO.

Some states do not allow limitations on implied warranties, so the above limitation may not apply to you.

In the event any defect occurs which is believed to be covered by this warranty, NIBCO Technical Services must immediately be contacted by calling 888.446.4226 or emailing CS-TechnicalServices@nibco.com. NIBCO Technical Services after being contacted will make further arrangements for the product’s return to NIBCO at the customer’s expense for review and evaluation.

This warranty gives you specific legal rights, and you may also have other rights which vary from state to state.



Chemtrol® is a brand of **NIBCO**

WARNING: DO NOT USE OR TEST THE PRODUCTS IN THIS CATALOG WITH COMPRESSED AIR OR OTHER GASES. FAILURE TO FOLLOW THIS WARNING CAN RESULT IN PERSONAL INJURY OR DAMAGE TO PROPERTY.

Revision 11/22/2021

Ideas
that flow.
Chemtrol®

Corzan® CPVC is a registered trademark of Lubrizol Advanced Materials.
Tru-Bloc® is a registered trademark of NIBCO INC.
Chem-Pure® is a registered trademark of NIBCO INC.
Chemcock® is a registered trademark of NIBCO INC.
Kynar® is a registered trademark of Arkema Inc.

Every solution begins with a good idea.

We've got ideas that flow directly to solutions for your industrial piping applications. Ideas that make your installations easier and more cost-effective. Ideas that work, and ideas that last. Our ideas are strengthened by a sound foundation for growth and a solid commitment to service.

For ideas that fit your flow-control applications, call on us. We're Chemtrol, a product line committed to innovation, growth, and superiority in thermoplastics—ideas whose time has come.

NIBCO INC.
World Headquarters
1516 Middlebury Street
PO Box 1167
Elkhart, IN 46515-1167
USA

Phone: 800.343.5455
Fax: 800.541.3841
Technical Service:
Phone: 888.446.4226
International Service:
Phone: +1.574.295.3327
Fax: +1.574.295.3455
www.chemtrol.com



C-CHE-0913-R120121